

CATALOG | NOVEMBER 2023

Low voltage

Process performance aluminum
motors, 400 V 50 Hz, 460 V 60 Hz

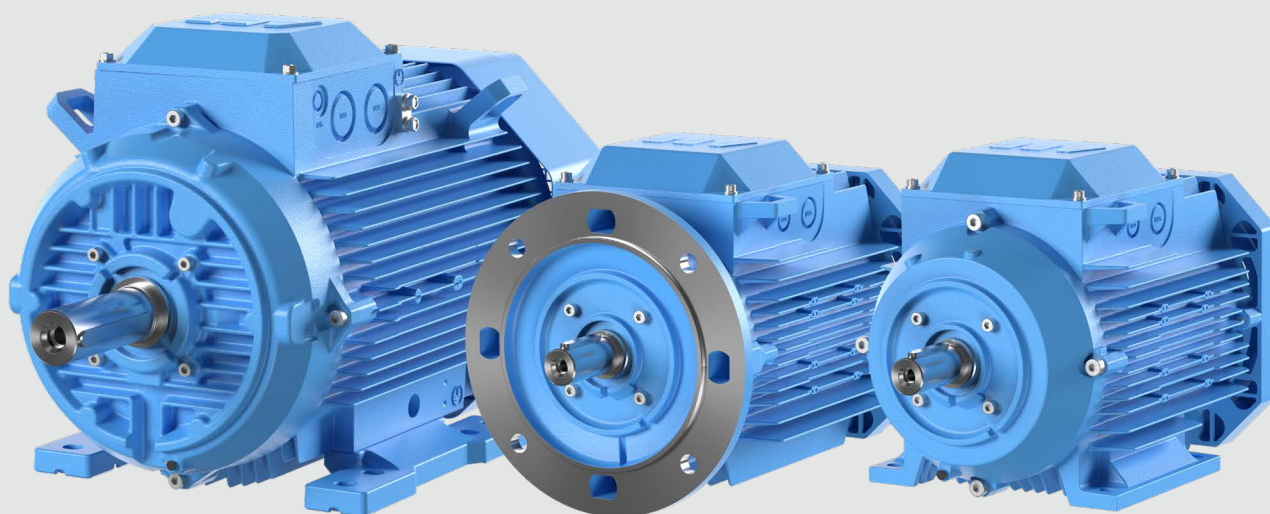

—
With expertise, and a comprehensive portfolio of products and life-cycle services, we help value-minded industrial customers improve their energy efficiency and productivity.

Low voltage

Process performance aluminum motors

Sizes 56 to 250, 0.09 to 90 kW

4	General information
4	International motor efficiency standards and regulations
7	Mounting arrangements
8	Cooling
9	Degrees of protection: IP code/IK code
10	Insulation
11	Voltage and frequency
12	Surface treatment
13	Variable speed drives with Process performance motors
17	Aluminum motors
18	Ordering information
19	Rating plates
20	Technical data
36	Variant codes
39	Mechanical design
51	Dimension drawings
53	Accessories
54	Aluminum motors in brief
57	Aluminum Ex ec and Ext motors
58	Introduction to explosive atmospheres
60	Ordering information
61	Rating plates
62	Technical data
68	Variant codes
71	Dimension drawings
72	Aluminum Ex ec and Ext t motors in brief
75	Brake motors
78	Ordering information
79	Rating plates
80	Technical data
82	Variant codes
85	Mechanical design
86	Brake design
91	Dimension drawings
92	Brake motors in brief
93	Total product offering
94	ABB's portfolio of drives

International motor efficiency standards and regulations

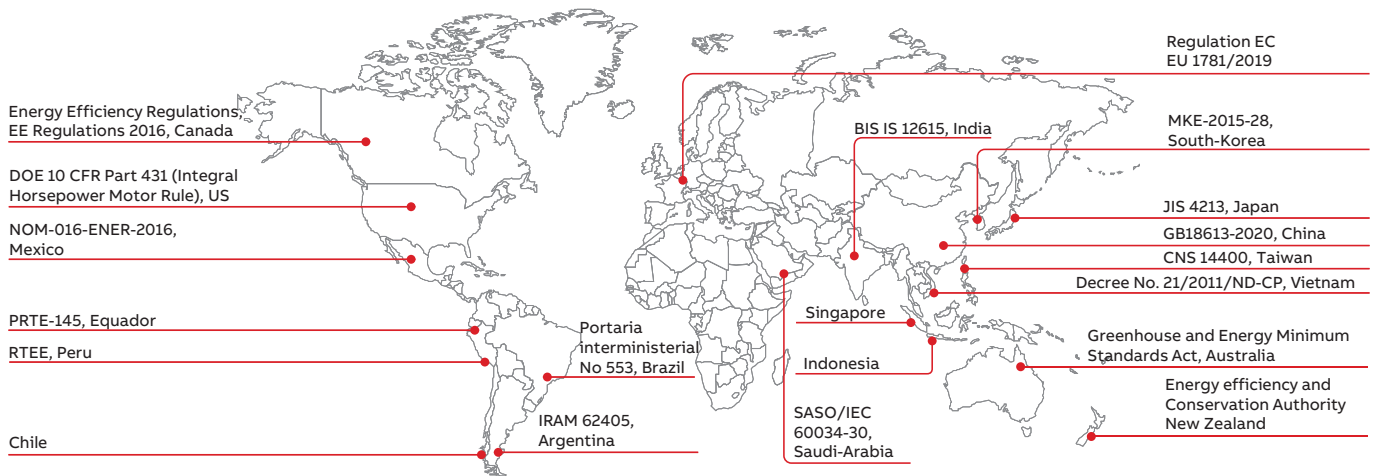

Since the validation of IEC 60034-30:2008 and its refined version IEC 60034-30-1:2014, a worldwide energy efficiency classification system has existed for low voltage three-phase asynchronous motors. These international standards have been created to enable and increase the level of harmonization in efficiency regulations around the world and to also cover motors for explosive atmospheres.

IEC 60034-30-1:2014 defines International Efficiency (IE) classes for single speed, three-phase, 50 Hz and 60 Hz induction motors. The efficiency levels defined in IEC 60034-30-1 are based on the test method specified in IEC 60034-2-1:2014. Both standards are part of an effort to unify motor testing procedures with CSA390-10 and IEEE 112 standards as well as efficiency and product labeling (IE) requirements to enable motor purchasers worldwide to easily recognize premium efficiency products.

To promote transparency in the market, IEC 60034-30-1 states that both the efficiency class and efficiency value must be shown on the motor rating plate and in product documentation. The documentation must clearly indicate the efficiency testing method used as different methods can produce differing results.

Minimum energy performance standards

While the IEC as an international standardization organization sets guidelines for motor testing and efficiency classes, the organization does not regulate efficiency levels in countries. The biggest drivers for mandatory Minimum Energy Per-

formance Standard (MEPS) levels for electric motors are global climate change, government targets to curb CO₂ emissions and rising electricity demand, especially in developing countries. The whole value chain, from manufacturer up to end user, must be aware of the legislation in order to meet local requirements, to save energy and reduce the carbon footprint.

Harmonized global standards and the increasing adoption of MEPS around the world are good news for all of us. However, it is important to remember that harmonization is an ongoing process. Even though MEPS are already in effect in several regions and countries, they are evolving and differ in terms of scope and requirements. At the same time, more countries are planning to adopt their own MEPS regulations. A view of existing and coming MEPS regulations in the world can be seen on the World map above.

To get the latest information please visit new.abb.com/motors-generators/energy-efficiency.

IEC 60034-30-1:2014

This standard defines four International Efficiency (IE) classes for single speed electric motors that are rated according to IEC 60034-1 or IEC 60079-0 (explosive atmospheres) and designed for operation on sinusoidal voltage.

- IE4 = Super premium efficiency
- IE3 = Premium efficiency, identical to the table in 10CFR431 ('NEMA Premium') in the USA and CSA C390-10:2015 for 60 Hz
- IE2 = High efficiency
- IE1 = Standard efficiency

IEC 60034-30-1 covers the power range from 0.12 kW up to 1000 kW. Most of the different technical constructions of electric motors are covered as long as they are rated for direct on-line operation. The coverage of the standard includes:

Single speed electric motors (single and three-phase), 50 and 60 Hz

- 2, 4, 6 and 8 poles
- Rated output P_N from 0.12 kW to 1000 kW
- Rated voltage U_N above 50 V up to 1 kV
- Motors capable of continuous operation at their rated power with a temperature rise within the specified insulation temperature class
- Motors, marked with any ambient temperature within the range of -20 °C to +60 °C
- Motors, marked with an altitude up to 4000 m above sea level

By comparing IEC 60034-30-1 to CSA C390-10:2015 and "10CFR431 Subpart B – Electric motors", it can be seen that the efficiency limits and tables are well aligned and their major difference is in the scope of the output power where CSA and 10CFR431 have a maximum power of 500 hp. There are also some minor differences in the scope of excluded motors.

Note: CFR is Code of Federal Regulations.

The following motors are excluded from IEC 60034-30-1:

Single-speed motors with 10 or more poles or multi-speed motors

- Motors completely integrated into a machine (for example pump, fan or compressor) that cannot be tested separately from the machine
- Brake motors, when the brake cannot be dismantled or separately fed

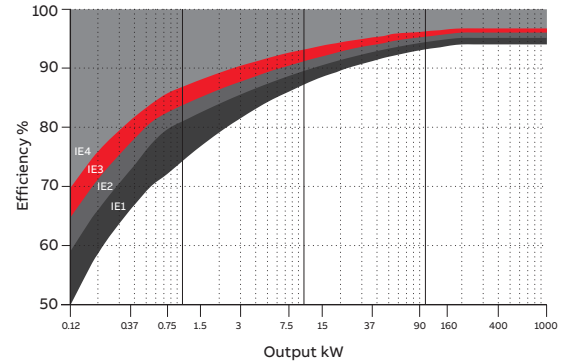

01

ABB and efficiency standards

ABB determines efficiency values according to IEC 60034-2-1 using the low uncertainty method (i.e. summation of losses), with additional load losses determined by the method of residual loss.

It is good to mention and emphasize that the IEC 60034-2-1 test method, which is known as an indirect method, is technically equivalent to the test methods in the standards CSA 390-10 and IEEE 112 Method B leading to the equivalent losses and thus efficiency values. Both test methods can be used by ABB and shall be used for both Canada and the US where IEC 60034-2-1 is not recognized yet.

As the world market leader, ABB offers the largest range of LV motors available. It has long advocated the need for efficiency in motors, and high efficiency products have formed the core of its portfolio for many years. The core of ABB's Process performance range is based on a full range of IE2 and IE3 motors – with many available from stock. We also supply IE4 motors for additional energy savings.

Nominal efficiency limits defined in IEC 60034-30-1:2014 (reference values at 50 Hz, based on test methods specified in IEC 60034-2-1:2014).

Output kW	IE1 Standard efficiency				IE2 High efficiency				IE3 Premium efficiency				IE4 Super Premium efficiency			
	2 pole	4 pole	6 pole	8 pole	2 pole	4 pole	6 pole	8 pole	2 pole	4 pole	6 pole	8 pole	2 pole	4 pole	6 pole	8 pole
0.12	45.0	50.0	38.3	31.0	53.6	59.1	50.6	39.8	60.8	64.8	57.7	50.7	66.5	69.8	64.9	62.3
0.18	52.8	57.0	45.5	38.0	60.4	64.7	56.6	45.9	65.9	69.9	63.9	58.7	70.8	74.7	70.1	67.2
0.20	54.6	58.5	47.6	39.7	61.9	65.9	58.2	47.4	67.2	71.1	65.4	60.6	71.9	75.8	71.4	68.4
0.25	58.2	61.5	52.1	43.4	64.8	68.5	61.6	50.6	69.7	73.5	68.6	64.1	74.3	77.9	74.1	70.8
0.37	63.9	66.0	59.7	49.7	69.5	72.7	67.6	56.1	73.8	77.3	73.5	69.3	78.1	81.1	78.0	74.3
0.40	64.9	66.8	61.1	50.9	70.4	73.5	68.8	57.2	74.6	78.0	74.4	70.1	78.9	81.7	78.7	74.9
0.55	69.0	70.0	65.8	56.1	74.1	77.1	73.1	61.7	77.8	80.8	77.2	73.0	81.5	83.9	80.9	77.0
0.75	72.1	72.1	70.0	61.2	77.4	79.6	75.9	66.2	80.7	82.5	78.9	75.0	83.5	85.7	82.7	78.4
1.1	75.0	75.0	72.9	66.5	79.6	81.4	78.1	70.8	82.7	84.1	81.0	77.7	85.2	87.2	84.5	80.8
1.5	77.2	77.2	75.2	70.2	81.3	82.8	79.8	74.1	84.2	85.3	82.5	79.7	86.5	88.2	85.9	82.6
2.2	79.7	79.7	77.7	74.2	83.2	84.3	81.8	77.6	85.9	86.7	84.3	81.9	88.0	89.5	87.4	84.5
3	81.5	81.5	79.7	77.0	84.6	85.5	83.3	80.0	87.1	87.7	85.6	83.5	89.1	90.4	88.6	85.9
4	83.1	83.1	81.4	79.2	85.8	86.6	84.6	81.9	88.1	88.6	86.8	84.8	90.0	91.1	89.5	87.1
5.5	84.7	84.7	83.1	81.4	87.0	87.7	86.0	83.8	89.2	89.6	88.0	86.2	90.9	91.9	90.5	88.3
7.5	86.0	86.0	84.7	83.1	88.1	88.7	87.2	85.3	90.1	90.4	89.1	87.3	91.7	92.6	91.3	89.3
11	87.6	87.6	86.4	85.0	89.4	89.8	88.7	86.9	91.2	91.4	90.3	88.6	92.6	93.3	92.3	90.4
15	88.7	88.7	87.7	86.2	90.3	90.6	89.7	88.0	91.9	92.1	91.2	89.6	93.3	93.9	92.9	91.2
18.5	89.3	89.3	88.6	86.9	90.9	91.2	90.4	88.6	92.5	92.6	91.7	90.1	93.7	94.2	93.4	91.7
22	89.9	89.9	89.2	87.4	91.3	91.6	90.9	89.1	92.7	93.0	92.2	90.6	94.0	94.5	93.7	92.1
30	90.7	90.7	90.2	88.3	92.0	92.3	91.7	89.8	93.3	93.6	92.9	91.3	94.5	94.9	94.2	92.7
37	91.2	91.2	90.8	88.8	92.5	92.7	92.2	90.3	93.7	93.9	93.3	91.8	94.8	95.2	94.5	93.1
45	91.7	91.7	91.4	89.2	92.9	93.1	92.7	90.7	94.0	94.2	93.7	92.2	95.0	95.4	94.8	93.4
55	92.1	92.1	91.9	89.7	93.2	93.5	93.1	91.0	94.3	94.6	94.1	92.5	95.3	95.7	95.1	93.7
75	92.7	92.7	92.6	90.3	93.8	94.0	93.7	91.6	94.7	95.0	94.6	93.1	95.6	96.0	95.4	94.2
90	93.0	93.0	92.9	90.7	94.1	94.2	94.0	91.9	95.0	95.2	94.9	93.4	95.8	96.1	95.6	94.4
110	93.3	93.3	93.3	91.1	94.3	94.5	94.3	92.3	95.2	95.4	95.1	93.7	96.0	96.3	95.8	94.7
132	93.5	93.5	93.5	91.5	94.6	94.7	94.6	92.6	95.4	95.6	95.4	94.0	96.2	96.4	96.0	94.9
160	93.8	93.8	93.8	91.9	94.8	94.9	94.8	93.0	95.6	95.8	95.6	94.3	96.3	96.6	96.2	95.1
200	94.0	94.0	94.0	92.5	95.0	95.1	95.0	93.5	95.8	96.0	95.8	94.6	96.5	96.7	96.3	95.4
250	94.0	94.0	94.0	92.5	95.0	95.1	95.0	93.5	95.8	96.0	95.8	94.6	96.5	96.7	96.5	95.4
315	94.0	94.0	94.0	92.5	95.0	95.1	95.0	93.5	95.8	96.0	95.8	94.6	96.5	96.7	96.6	95.4
355	94.0	94.0	94.0	92.5	95.0	95.1	95.0	93.5	95.8	96.0	95.8	94.6	96.5	96.7	96.6	95.4
400	94.0	94.0	94.0	92.5	95.0	95.1	95.0	93.5	95.8	96.0	95.8	94.6	96.5	96.7	96.6	95.4
450	94.0	94.0	94.0	92.5	95.0	95.1	95.0	93.5	95.8	96.0	95.8	94.6	96.5	96.7	96.6	95.4
500-1000	94.0	94.0	94.0	92.5	95.0	95.1	95.0	93.5	95.8	96.0	95.8	94.6	96.5	96.7	96.6	95.4

Mounting arrangements

Foot-mounted motor

Code I / code II

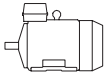
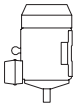
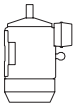
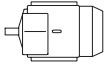
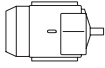
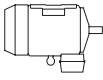
					
IM B3	IM V5	IM V6	IM B6	IM B7	IM B8
IM 1001	IM 1011	IM 1031	IM 1051	IM 1061	IM 1071

Product code pos. 12

A: foot-mounted, term. box top
 R: foot-mounted, term. box RHS
 L: foot-mounted, term. box LHS

Flange-mounted motor, large flange

Code I / code II

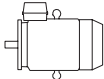
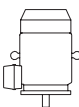
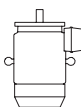
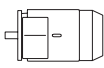
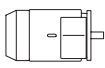
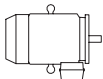
					
IM B5	IM V1	IM V3	*)	*)	*)
IM 3001	IM 3011	IM 3031	IM 3051	IM 3061	IM 3071

Product code pos. 12

B: flange mounted, large flange

Flange-mounted motor, small flange

Code I / code II

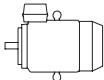
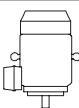
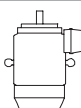
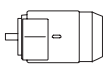
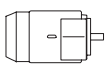
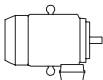
					
IM B14	IM V18	IM V19	*)	*)	*)
IM 3601	IM 3611	IM 3631	IM 3651	IM 3661	IM 3671

Product code pos. 12

C: flange mounted, small flange

Foot- and flange-mounted motor with feet, large flange

Code I / code II

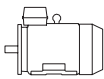
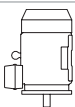
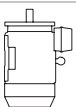
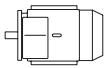
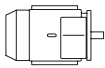
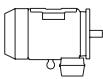
					
IM B35	IM V15	IM V35	*)	*)	*)
IM 2001	IM 2011	IM 2031	IM 2051	IM 2061	IM 2071

Product code pos. 12

H: foot/flange-mounted, term. box top
 S: foot/flange-mounted, term. box RHS
 T: foot/flange-mounted, term. box LHS

Foot- and flange-mounted motor with feet, small flange

Code I / code II

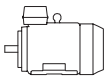
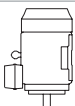
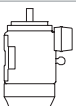
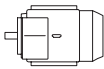
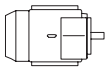
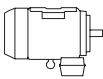
					
IM B34	IM V17				
IM 2101	IM 2111	IM 2131	IM 2151	IM 2161	IM 2171

Product code pos. 12

J: foot/flange-mounted, small flange

Foot-mounted motor, shaft with free extensions

Code I / code II

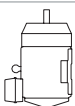
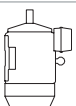
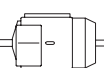
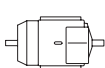
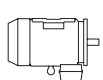
					
IM 1002	IM 1012	IM 1032	IM 1052	IM 1062	IM 1072

Product code pos. 12

*) Not stated in IEC 60034-7.

Note: If the motor is mounted shaft upwards, take measures to prevent water or any other liquid from running down the shaft into the motor.

General information

Cooling

Designation system concerning methods of cooling refers to standard IEC 60034-6.

Explanation of the product code

International Cooling	Circuit arrangement	Primary coolant	Method of movement of primary coolant	Secondary coolant	Method of movement of secondary coolant
IC	4	(A)	1	(A)	6
	1	2	3	4	5

Position 1

- 0: Free circulation (open circuit)
- 4: Free circulatio (open circuit)

Position 2

- A: For air (omitted for simplifi ed designation)

Position 3

- 0: Free convection
- 1: Self-circulation
- 6: Machine-mounted independent component

Position 4

- A: For air (omitted for simplifi ed designation)
- W: For water

Position 5

- 0: Free convection
- 1: Self-circulation
- 6: Machine-mounted independent component
- 8: Relative displacement

General information

Degrees of protection: IP code/IK code

Classification of degrees of protection provided by enclosures of rotating machines are refers to:

- Standard IEC 60034-5 or EN 60529 for IP code
- Standard EN 50102 for IK code

IP protection

Protection of persons against getting in contact with (or approaching) live parts and against contact with moving parts inside the enclosure. Also protection of the machine against ingress of solid foreign objects. Protection of machines against the harmful effects due to the ingress of water.

Explanation of the IP code

Ingress protection	Degree of protection to persons and to parts of the motors inside the enclosure	Degree of protection provided by the enclosure with respect to harmful effects due to ingress of water
IP	5	5
	1	2

Position 1

2:	Motors protected against solid objects greater than 12 mm
4:	Motors protected against solid objects greater than 1 mm
5:	Dust-protected motors
6:	Dust-tight motors

Position 2

3:	Motors protected against spraying water
4:	Motors protected against splashing water
5:	Motors protected against water jets
6:	Motors protected against heavy seas

IK code

Classification of degrees of protection provided by enclosure for motors against external mechanical impacts.

Explanation of the IK code

International mechanical protection	Characteristic group
IK	08
	1

Position 1

Relation between IK code and impact energy:

IK code	Impact energy/Joule
0:	Not protected according to EN 50102
01:	0.15
02:	0.2
03:	0.35
04:	0.5
05:	0.7
06:	1
07:	2
08:	5 (ABB Standard)
09:	10
10:	20

Insulation

01 Safety margins per thermal class.

ABB uses class F insulation, which, with temperature rise B, is the most common requirement among industry today.

The use of class F insulation with class B temperature rise gives ABB products a 25 °C safety margin. This can be used to increase the loading for limited periods, to operate at higher ambient temperatures or altitudes, or with greater voltage and frequency tolerances. It can also be used to extend insulation. For instance, a 10 K temperature reduction will extend the insulation life.

Thermal class 130 (B)

- Nominal ambient temperature 40 °C
- Max permissible temperature rise 80 K
- Hot spot temperature margin 10 K

Thermal class 155 (F)

- Nominal ambient temperature 40 °C
- Max permissible temperature rise 105 K
- Hot spot temperature margin 10 K

Thermal class 180 (H)

- Nominal ambient temperature 40 °C
- Max permissible temperature rise 125 K
- Hot spot temperature margin 10 K

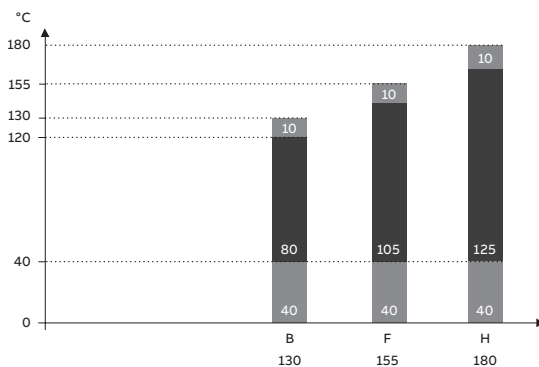

01

General information

Voltage and frequency

01 Voltage and frequency deviation in zones A and B.

The impact on temperature rise caused by voltage and frequency fluctuation is defined in IEC 60034-1. The standard divides the combinations into two zones, A and B. Zone A is the combination of voltage deviation of +/-5 % and frequency deviation of +/-2 %. Zone B is the combination of voltage deviation of +/-10 % and frequency deviation of +/-5 %. This is illustrated in figure below.

Motors are capable of supplying the rated torque in both zones A and B, but the temperature rise will be higher than at rated voltage and frequency. Motors can be run in zone B only for a short period of time.

Key	
X axis	frequency p.u.
Y axis	voltage p.u.
1	zone A
2	zone B (outside zone A)
3	rating point

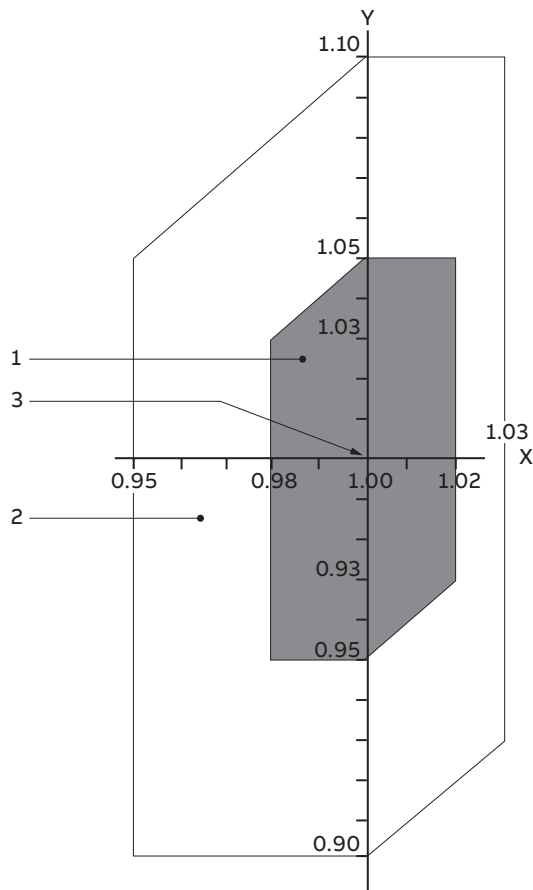

01

Surface treatment

The standard surface treatment of the Process performance motors is designed to meet corrosivity category C3, both outdoors and indoors. This also meets the requirements in C1 and C2.

The standard ABB paint color for motors is Munsell blue 8B 4.5/3.25.

The corrosivity categories are defined in standard ISO12944-2.

Atmospheric-corrosivity categories and examples of typical environments

Corrosivity category	Examples of typical environments (informative only)	
	Exterior	Interior
C1	-	Heated buildings with clean atmospheres, e.g., offices, shops, schools, hotels
C2	Atmospheres with low levels of pollution: mostly rural areas	Unheated buildings where condensation can occur, e.g., depots, sports halls
C3	Urban and industrial atmospheres, moderate sulfur dioxide pollution; coastal areas with low salinity	Production rooms with high humidity and some air pollution, e.g., food-processing plants, laundries, breweries, dairies
C4	Industrial areas and coastal areas with moderate salinity	Chemical plants, swimming pools, coastal ship- and boatyards
C5	Industrial areas with high humidity and an aggressive atmosphere, and coastal areas with high salinity	Buildings or areas with almost permanent condensation and with high pollution
CX	Offshore areas with high salinity, and industrial areas with extreme humidity and an aggressive atmosphere, and sub-tropical and tropical atmospheres	Industrial areas with extreme humidity and an aggressive atmosphere

Variable speed drives with Process performance motors

01 Isotherm loadability curves for motors with 50Hz nominal frequency

Variable speed drives (VSD) provide significant benefits when used together with ABB Process performance motors. The advantages include better process control and energy savings through a regulation of motor speed, and smooth starting with a reduced inrush current, reducing the stress on the equipment and supply network.

By choosing an ABB motor–drive package, users can be confident that the motor and drive combination is optimized for their application; it is a working package with a known performance.

Process performance motors are designed for both direct on line (DOL) and variable speed operation, and will, either as standard or by adding a few extras, be suitable for variable speed operations.

When selecting process performance motors for VSDs, the following points must be taken into consideration. The DriveSize selection tool helps in selecting the optimal combination of motor, drive and supply transformer.

Motor loadability with variable speed drives

The difference in the temperature rise of a motor run direct on line compared to the same motor run with a drive is influenced by factors such as the cooling effect of a shaft-mounted fan, depending on the speed of the motor, increased losses due to harmonics generated by the drive and reduced flux above the field weakening point. The effects of all these factors are combined in the loadability curves.

The isotherm loadability curves in Figure 01 show the maximum continuous load torque as a function of frequency (speed), which results in the same temperature rise as an operation with the rated sinusoidal supply at a nominal frequency and full rated load. These curves are based on measurements with ABB ACS880 drives.

The motor's maximum continuous loadability depends on the motor's actual temperature rise and the desired or allowed maximum temperature rise, typically class B or class F. Use the DriveSize

dimensioning tool to choose the right motor and drive for your application. In DriveSize, you can specify the desired temperature rise and the tool scales the loadability curve according to the actual motor temperature rise.

If the motor is loaded according to the temperature rise F, it will be necessary to check the temperature rise in other parts of the motor and ensure that the lubrication intervals and grease type are still appropriate.

Many applications also demand short time overloadability. In the DriveSize tool, you can also specify short time overload needs and the tool will choose the right products for your task.

Temperature rise B

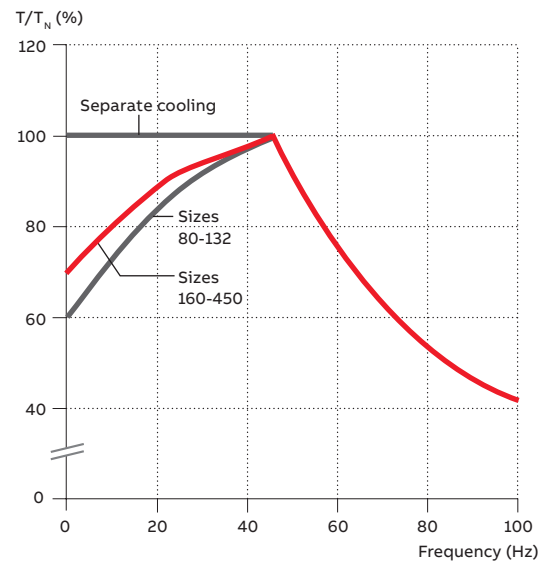

01

Operating speed

Process performance motors are designed to work over a wide speed range and also at speeds significantly higher than nominal. The maximum speeds can be found on motor rating plates or in DriveSize. In addition to the motor speed, make sure that the maximum or critical speed of the entire application is not exceeded.

—
 02 Maximum allowed phase-to-phase voltage peaks at motor terminals, as a function pulse rise time.

Ventilation

When the motor is operating at low speeds, the cooling capacity of the fan decreases, which again reduces the motor's load capacity. A separate, constant-speed fan (variant code 183) can be used to increase the cooling capacity at low speed, if required for loads with constant torque characteristics.

Lubrication

The lubrication interval of regreasable bearings depends on the running speed of the motor and the bearing temperature. Smaller motors usually have greased, sealed-for-life bearings. Please refer to the installation, operation and safety manual for further information on lubrication.

Winding insulation

To ensure that motors operate reliably, the effects of non-sinusoidal output voltages from the converter must be taken into consideration when selecting the correct insulation system for the motor and output filters for the drive. The insulation and filters must be selected according to the table below.

Winding insulation and filters required	
$U_N \leq 500$ V	Standard insulation
$U_N \leq 600$ V	Standard insulation + dU/dt filters OR Special insulation (variant code 405)
$U_N \leq 690$ V	Special insulation (variant code 405) AND dU/dt-filters at converter output
600 V < $U_N \leq 690$ V cable length > 150 m	Special insulation (variant code 405)

Table 1. Guideline maximum speed values for Process performance motors.

For more information on dU/dt filters, see the relevant ABB drives documents.

For other drives and cases where the guidelines shown in table above cannot be applied, the selection must be based on the voltages present at the motor terminals.

Allowed phase-to-ground voltage peaks at motor terminals:

- 1,300 V peak: standard insulation
- 1,800 V peak: special insulation, variant code 405

The maximum allowed phase-to-phase voltage peaks at the motor terminals as a function of the pulse rise time are shown in Figure 02. The higher curve (special insulation) applies to motors with special winding insulation for a variable speed

drive supply. Standard insulation applies to motors with a standard design.

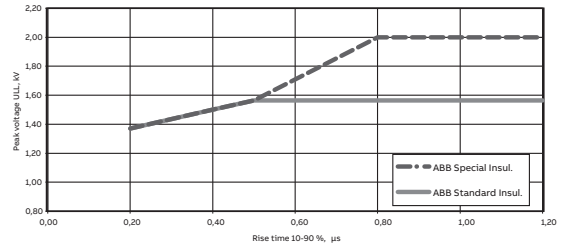

—
 02

Bearing currents

Bearing voltages and currents must be avoided in all motors to ensure reliable operation of the entire application. Table 2 below gives the selection rules, depending on motor output power and frame size, when used together with ABB drive products; the same rules can also be applied as guidance when using ABB Process performance motors with other manufacturers' drives.

Nominal power (P_N and / or Frame size (IEC))	Precautionary measures
$P_N < 100$ kW	No action needed
$P_N \geq 100$ kW OR IEC 315 ≤ Frame size ≤ IEC 355	Insulated non-drive end bearing
$P_N \geq 350$ kW OR IEC 400 ≤ Frame size ≤ IEC 450	Insulated non-drive end bearing AND Common mode filter at the converter

Table 2. Precautionary measures to avoid bearing currents in variable speed drives.

Common mode filters

Common mode filters are installed at the output of the variable speed drive. These filters reduce common mode currents and, thus, decrease the risk of bearing currents. Common mode filters do not significantly affect the phase of main voltages on motor terminals. For more information, see the ABB drives documents.

Insulated bearings

ABB uses bearings with an insulated outer race or hybrid bearings with ceramic rolling elements.

Insulated bearings at the non-drive end can be ordered by using variant code 701.

Earthing and cabling

For motors with a nominal power above 30 kW, cables with a symmetrical concentric protective earth should be used across the system. The same type of cables are also recommended for motors with an output of 30 kW and below.

Electromagnetic compatibility (EMC)

The high-frequency components in a variable speed drive might cause electromagnetic interference with other equipment in the installation. To avoid this, certain measures should be taken. To meet EMC requirements, special EMC cables glands with a 360° connection to the concentric protective earth conductor should be used. Such cable glands can be used with variant code 704.

Low voltage

Process performance aluminum motors

Sizes 56 to 250, 0.09 to 90 kW

18	Ordering information
19	Rating plates
20	Technical data 400 V 50 Hz
20	IE3 aluminum motors
23	IE2 aluminum motors
28	Technical data 460 V 60 Hz
28	IE3 aluminum motors
31	IE2 aluminum motors
36	Variant codes
39	Mechanical design
39	Motor frame and drain holes
40	Bearings
48	Terminal box
51	Dimension drawings
51	IE3 aluminum motors
52	IE2 aluminum motors
53	Accessories
53	Slide rails
54	Aluminum motors in brief
54	Motor sizes 56 - 132
55	Motor sizes 160 - 250

Ordering information

Explanation of the product code

Motor type	Motor size	Product code	Code for mounting arrangement, Voltage and frequency code, Generation code followed by variant codes
M3AA	112MB	3GAA 111	320 - ADK, 122, 003 etc.
		1 2 3 4 5 6 7 8 9 10 11 12 13 14...	

Positions 1 to 4	
3GAA:	Totally enclosed motor with aluminum stator frame

Positions 5 and 6			
IEC size		IEC size	
05:	56	13:	132
06:	63	16:	160
07:	71	18:	180
08:	80	20:	200
09:	90	22:	225
10:	100	25:	250
11:	112	28:*	280

Position 7	
Pole pairs	
1:	2 poles
2:	4 poles
3:	6 poles
4:*	8 poles
5:*	10 poles
6:*	12 poles
7:*	> 12 poles

Positions 8 to 10	
Running number	

Position 11	
- (dash)	

Position 12 (marked with black dot in data tables)	
Mounting arrangement	
A:	Foot-mounted motor
B:	Flange-mounted motor. Large flange with clearance holes.
C:	Flange-mounted motor. Small flange with tapped holes.
F:*	Foot- and flange-mounted motor. Special flange.
H:	Foot- and flange-mounted motor. Large flange with clearance holes.
J:	Foot- and flange-mounted motor. Small flange with tapped holes.
N:*	Flange-mounted (CI ring flange FF)
P:*	Foot-and flange-mounted motor (CI ring flange FF)
V:*	Flange-mounted motor. Special flange.

Position 13 (marked with black dot in data tables)	
Voltage and frequency code	
Single-speed motors	
B:*	380 VΔ 50 Hz
D:	400 VΔ, 415 VΔ, 690 VY 50 Hz
E:*	500 VΔ 50 Hz
F:*	500 VY 50 Hz
S:	230 VΔ, 400 VY, 415 VY 50 Hz
T:*	660 VΔ 50 Hz
U:*	690 VΔ 50 Hz
X:*	Other rated voltage, connection or frequency, 690 V maximum

Position 14	
Version	
A, B, C...: Generation code followed by variant codes	

Efficiency values are given according to IEC 60034-2-1; 2014

* Not as standard offering, can be ordered as customer-specific solution.

Rating plates

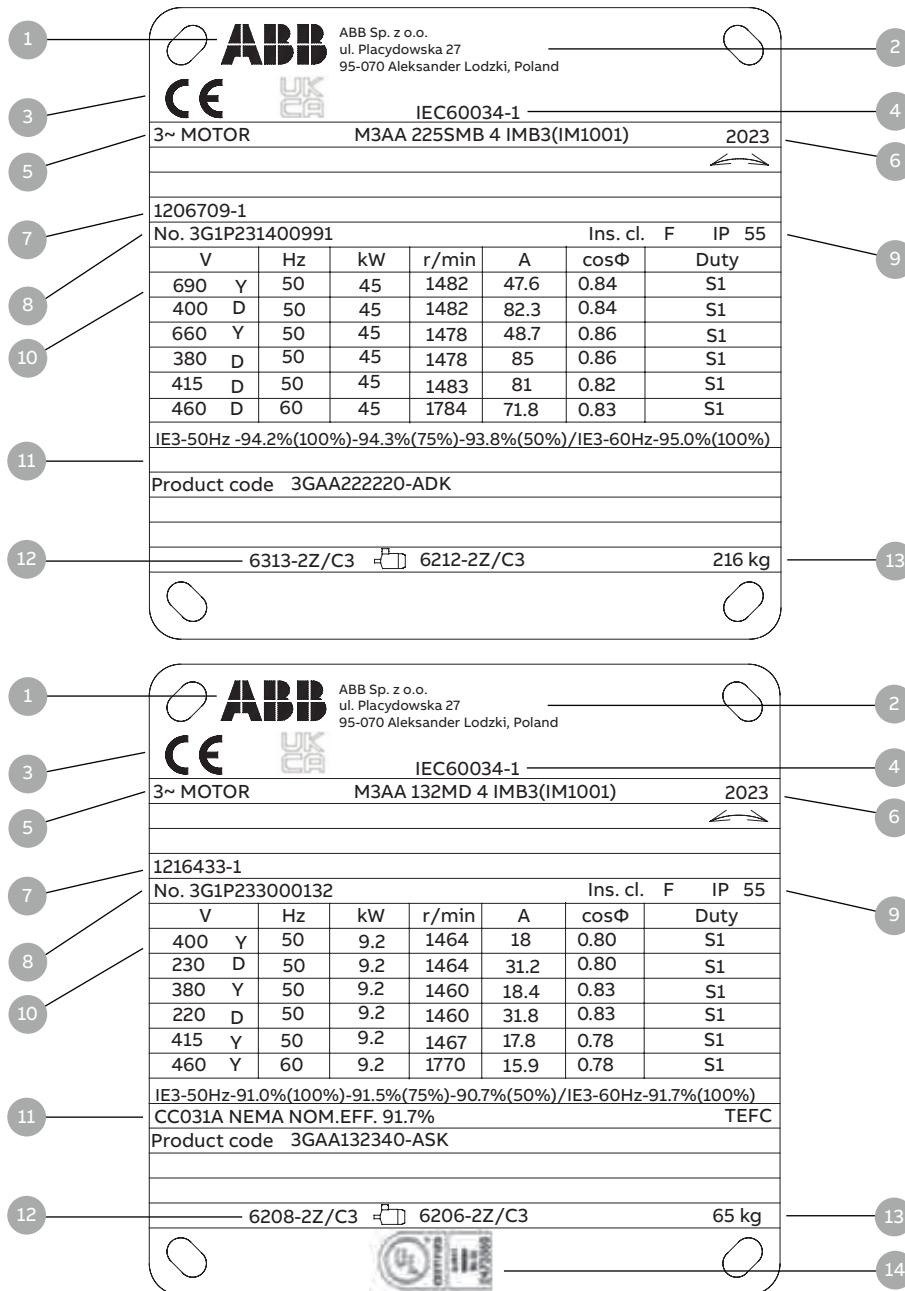

- 1 ABB logo
- 2 Manufacturing place
- 3 CE mark on Ecodesign approved motors UKCA mark on UK approved motors
- 4 Manufacturing standard
- 5 Product description
- 6 Manufacturing year
- 7 Factory order reference number
- 8 Serial number
- 9 Insulation class, IP protection class
- 10 Voltage, Frequency, output, speed, current, power factory, duty
- 11 Product code
- 12 Bearing type
- 13 Weight
- 14 US/CA safety and efficiency in standard

Technical data, 400 V 50 Hz

IE3 Process performance aluminum motors

IP 55 - IC 411 - Insulation class F, temperature rise class B
IE3 efficiency class according to IEC 60034-30-1: 2014

Output kW	Motor type	Product code	Speed r/min	Efficiency IEC 60034-30-1: 2014			Power factor Cos ϕ	Current		Torque		Moment of inertia J = 1/4 GD ² kgm ²	Weight kg	Sound pressure Level L _{PA} dB	
				Full load 100%	3/4 load 75%	1/2 load 50%		I _N A	I _S /I _N	T _N Nm	T _I /T _N				T _B /T _N
3000 r/min = 2 poles			400 V 50 Hz			CENELEC-design									
0.75	M3AA 80MB 2	3GAA081320-..K	2894	80.7	80.4	77.2	0.74	1.74	7.9	2.4	3.7	4.2	0.0008	9.5	57
1.1	M3AA 80MC 2	3GAA081330-..K	2883	82.7	82.4	80.6	0.81	2.3	7.9	3.6	3.7	4.2	0.001	10.5	56
1.5	M3AA 90LB 2	3GAA091520-..K	2906	84.2	84.8	84.7	0.89	2.8	7.9	4.9	2.3	3.3	0.0027	17	60
2.2	M3AA 90LC 2	3GAA091530-..K	2900	85.9	87.4	87.5	0.89	4	8.3	7.2	2.9	3.5	0.0032	20	60
3	M3AA 100LC 2	3GAA101530-..K	2896	87.1	88.2	88.0	0.90	5.4	8.4	9.8	3.2	3.9	0.0057	28	62
4	M3AA 112MB 2	3GAA111320-..K	2888	88.1	89.4	89.6	0.91	7.1	8.4	13.2	3.2	4.0	0.0104	38	68
5.5	M3AA 132SB 2	3GAA131120-..K	2901	89.2	89.9	90.1	0.91	9.7	7.9	18.1	2.3	3.4	0.0154	58	68
7.5	M3AA 132SC 2	3GAA131130-..K	2909	90.1	91.2	91.4	0.90	13.1	8.3	24.6	3.0	3.9	0.0173	63	70
11	M3AA 160MLA 2	3GAA161410-..K	2943	91.2	92.0	91.6	0.91	19.1	7.2	35.57	2.6	3.6	0.057	106	69
15	M3AA 160MLB 2	3GAA161420-..K	2947	91.9	92.2	91.8	0.88	26.7	8.2	48.6	3.2	4.2	0.063	123	69
18.5	M3AA 160MLC 2	3GAA161430-..K	2949	92.4	93.0	92.6	0.90	32.1	9.0	59.9	3.3	3.9	0.076	137	73
22	M3AA 180MLA 2	3GAA181410-..K	2956	92.7	93.1	92.7	0.90	37.7	7.8	71.0	3.0	3.8	0.11	176	73
30	M3AA 200MLA 2	3GAA201410-..K	2962	93.3	93.5	92.8	0.87	53.2	7.6	96.8	3.1	3.8	0.159	225	72
37	M3AA 200MLB 2	3GAA201420-..K	2961	93.7	94.1	93.8	0.88	64.4	8.2	119	3.0	3.3	0.196	241	72
45	M3AA 225SMA 2	3GAA221210-..K	2968	94.0	94.0	93.0	0.87	79.6	7.3	145	3.2	3.1	0.296	326	76
55	M3AA 250SMA 2	3GAA251210-..K	2968	94.3	93.7	93.6	0.89	94.8	6.8	177	2.4	3.0	0.426	351	76

Output kW	Motor type	Product code	Speed r/min	Efficiency IEC 60034-30-1: 2014			Power factor Cos ϕ	Current		Torque		Moment of inertia J = 1/4 GD ² kgm ²	Weight kg	Sound pressure Level L _{PA} dB	
				Full load 100%	3/4 load 75%	1/2 load 50%		I _N A	I _S /I _N	T _N Nm	T _I /T _N				T _B /T _N
3000 r/min = 2 poles			400 V 50 Hz			High-output design									
2.75	M3AA 90LD 2	3GAA091540-..K	2872	87.1	88.2	88.0	0.83	5.4	7.5	9.1	4.4	5.0	0.00407	20	65
4	M3AA 100LD 2	3GAA101540-..K	2910	88.1	89.7	89.7	0.91	7.12	8.6	13.1	3.9	4.8	0.00787	40	67
5.5	M3AA 112MC 2	3GAA111330-..K	2909	89.2	90.6	90.8	0.91	9.67	8.6	18.1	4.3	5.5	0.0132	48	73
9.2	M3AA 132SD 2	3GAA131140-..K	2910	90.7	91.7	91.7	0.90	15.9	8.2	29.9	3.4	4.3	0.0168	71	75
11	M3AA 132SME 2	3GAA131250-..K	2922	91.2	91.8	91.5	0.90	19.8	10.6	36.0	4.5	5.4	0.0231	90	75
15	M3AA 132SMF 2	3GAA131260-..K	2908	91.9	93.2	93.5	0.91	25.8	9.8	49.3	4.4	5.5	0.023	90	75
22	M3AA 160MLD 2	3GAA161440-..K	2944	92.7	93.5	93.4	0.90	38	8.4	71.4	3.2	3.7	0.071	131	74
30	M3AA 180MLB 2	3GAA181420-..K	2957	93.3	94.0	93.9	0.88	52.7	8.7	96.9	3.0	3.8	0.104	162	74
37 ¹⁾	M3AA 180MLC 2	3GAA181430-..K	2950	93.7	94.2	94.2	0.86	66	8.4	119.5	3.4	4.4	0.117	176	74
45	M3AA 200MLC 2	3GAA201430-..K	2956	94.0	94.6	94.8	0.89	77.2	7.8	145.2	2.9	3.3	0.216	250	77
55	M3AA 225SMB 2	3GAA221220-..K	2964	94.3	94.4	93.9	0.86	97.4	7.2	177.3	3.14	3.22	0.299	288	79
75 ¹⁾	M3AA 225SMC 2	3GAA221230-..K	2966	94.7	95	94.7	0.86	132	7.5	241.7	3.08	3.06	0.361	328	79
75 ¹⁾	M3AA 250SMB 2	3GAA251220-..K	2971	94.7	95.1	94.8	0.90	127	7.9	241.1	2.8	3.3	0.644	405	81
90 ¹⁾	M3AA 250SMC 2	3GAA251230-..K	2975	95	95.2	94.6	0.87	156	8.5	288.6	2.91	3.6	0.514	414	81

¹⁾ Temperature rise class F

Technical data, 400 V 50 Hz

IE3 Process performance aluminum motors

IP 55 - IC 411 - Insulation class F, temperature rise class B
IE3 efficiency class according to IEC 60034-30-1: 2014

Output kW	Motor type	Product code	Speed r/min	Efficiency IEC 60034-30-1: 2014			Power factor Cos ϕ	Current		Torque		Moment of inertia J = 1/4 GD ² kgm ²	Weight kg	Sound pressure Level L _{PA} dB	
				Full load 100%	3/4 load 75%	1/2 load 50%		I _N A	I _s /I _N	T _N Nm	T _I /T _N				T _B /T _N
1500 r/min = 4 poles			400 V 50 Hz					CENELEC-design							
0.75	M3AA 80ME 4	3GAA082350-..K	1440	82.5	82.4	80.2	0.76	1.68	7.9	4.9	3.3	3.7	0.0027	13.5	54
1.1	M3AA 90LC 4	3GAA092530-..K	1442	84.1	83.5	81.7	0.80	2.3	7.9	7.2	3.3	3.9	0.0055	19	56
1.5	M3AA 90LD 4	3GAA092540-..K	1439	85.3	84.7	82.8	0.78	3.2	8.2	9.9	3.5	4.0	0.0055	19	51
2.2	M3AA 100LE 4	3GAA102550-..K	1454	86.7	87.1	86.0	0.83	4.3	8.9	14.5	3.1	4.1	0.0144	36	54
3	M3AA 100LF 4	3GAA102560-..K	1452	87.7	88.1	87.1	0.83	5.9	9.0	19.7	3.5	4.2	0.0144	36	54
4	M3AA 112MB 4	3GAA112320-..K	1451	88.6	89.4	89.0	0.77	8.6	7.6	26.3	3.1	4.1	0.018	44	59
5.5	M3AA 132MB 4	3GAA132320-..K	1464	89.6	90.2	89.5	0.78	11.4	7.0	35.9	2.8	3.9	0.0295	68	70
7.5	M3AA 132MC 4	3GAA132330-..K	1464	90.4	90.8	90.7	0.81	14.7	7.7	48.9	2.5	3.6	0.0414	68	64
11	M3AA 160MLA 4	3GAA162410-..K	1477	91.4	91.8	91.1	0.82	21.1	7.6	71.3	2.6	3.3	0.11	126	61
15	M3AA 160MLB 4	3GAA162420-..K	1474	92.1	92.2	91.3	0.81	29	7.8	97.2	3.0	3.6	0.135	140	61
18.5	M3AA 180MLA 4	3GAA182410-..K	1481	92.6	93.2	92.9	0.83	34.9	7.2	119.3	2.8	3.0	0.219	177	60
22	M3AA 180MLB 4	3GAA182420-..K	1480	93.0	93.8	93.8	0.82	41.5	8.2	141.0	2.8	3.1	0.217	176	62
30	M3AA 200MLA 4	3GAA202410-..K	1481	93.6	93.9	93.4	0.84	55	7.5	193.4	2.7	3.2	0.385	246	63
37	M3AA 225SMA 4	3GAA222210-..K	1481	93.9	94.1	93.4	0.82	69.8	8.0	235.4	3.3	3.5	0.433	315	67
45	M3AA 225SMB 4	3GAA222220-..K	1482	94.2	94.4	94.0	0.84	82.3	8.0	290.0	3.1	3.5	0.525	316	66
55	M3AA 250SMA 4	3GAA252210-..K	1485	94.6	95.2	94.9	0.85	97.8	7.9	353.0	3.0	3.3	0.933	376	67

Output kW	Motor type	Product code	Speed r/min	Efficiency IEC 60034-30-1: 2014			Power factor Cos ϕ	Current		Torque		Moment of inertia J = 1/4 GD ² kgm ²	Weight kg	Sound pressure Level L _{PA} dB	
				Full load 100%	3/4 load 75%	1/2 load 50%		I _N A	I _s /I _N	T _N Nm	T _I /T _N				T _B /T _N
1500 r/min = 4 poles			400 V 50 Hz					High-output design							
5.5	M3AA 112MC 4	3GAA112330-..K	1454	89.6	90.0	88.6	0.78	11.2	8.0	39.2	3.9	4.3	0.0234	50	64
9.2	M3AA 132MD 4	3GAA132340-..K	1464	91.0	91.7	91.3	0.80	18	8.5	60	3.0	4.0	0.0392	65	75
11	M3AA 132SME 4	3GAA132250-..K	1464	91.4	92.0	91.6	0.79	21.8	8.2	71.56	3.1	4.1	0.0468	88	75
15	M3AA 132SMF 4	3GAA132260-..K	1464	92.1	92.6	92.1	0.79	29.7	9.0	97.52	3.4	4.5	0.0545	88	75
18.5	M3AA 160MLC 4	3GAA162430-..K	1476	92.6	93.1	92.7	0.77	37.2	8.3	119.9	3.3	3.6	0.12	135	67
28	M3AA 180MLC 4	3GAA182430-..K	1482	93.4	93.3	92.3	0.77	56.5	8.2	180.4	3.0	3.6	0.191	176	62
37	¹⁾ M3AA 200MLB 4	3GAA202420-..K	1482	93.9	94.1	93.7	0.82	69.3	7.8	237.9	3.1	3.3	0.362	244	68
53	M3AA 225SMC 4	3GAA222230-..K	1483	94.5	94.7	94.2	0.83	97	8.7	341.34	3.15	3.41	0.532	318	71
75	M3AA 250SMB 4	3GAA252220-..K	1483	95.0	95.3	95.0	0.82	139	7.8	485.8	3.28	3.46	0.796	389	73

¹⁾ Temperature rise class F

Technical data, 400 V 50 Hz

IE3 Process performance aluminum motors

IP 55 - IC 411 - Insulation class F, temperature rise class B
IE3 efficiency class according to IEC 60034-30-1: 2014

Output kW	Motor type	Product code	Speed r/min	Efficiency IEC 60034-30-1: 2014			Power factor Cos ϕ	Current		Torque		Moment of inertia J = 1/4 GD ² kgm ²	Weight kg	Sound pressure Level L _{PA} dB	
				Full load 100%	3/4 load 75%	1/2 load 50%		I _N A	I _S /I _N	T _N Nm	T _I /T _N				T _B /T _N
1000 r/min = 6 poles			400 V 50 Hz					CENELEC-design							
0.75	M3AA 90LD 6	3GAA093540-**K	937	78.9	79.6	77.3	0.76	1.78	4.6	7.6	2.1	2.3	0.0055	19	55
1.1	M3AA 100LE 6	3GAA103550-**K	963	81.0	82.2	81.0	0.69	2.6	5.6	10.9	2.3	3.1	0.0138	35	49
1.5	M3AA 100LF 6	3GAA103560-**K	969	82.5	81.4	77.5	0.65	3.7	7.0	14.7	3.3	4.1	0.0138	35	49
2.2	M3AA 112MC 6	3GAA113330-**K	967	84.3	85.2	84.1	0.69	5.2	6.5	21.7	2.4	3.5	0.0187	43	68
3	M3AA 132MC 6	3GAA133330-**K	978	85.6	86.0	84.5	0.69	7	6.2	29.2	2.0	3.0	0.0402	66	61
4	M3AA 132MD 6	3GAA133340-**K	973	86.8	87.7	87.5	0.72	9.1	5.6	39.2	1.9	2.7	0.0402	67	61
5.5	M3AA 132ME 6	3GAA133350-**K	973	88.0	88.8	88.2	0.74	12	5.8	53.9	2.0	2.9	0.039	63	61
7.5	M3AA 160MLA 6	3GAA163410-**K	980	89.1	89.9	89.3	0.78	15.2	7.9	73.0	1.7	3.3	0.114	125	59
11	M3AA 160MLB 6	3GAA163420-**K	979	90.3	90.9	90.2	0.74	23.5	8.5	107.0	2.2	3.9	0.131	139	59
15	M3AA 180MLA 6	3GAA183410-**K	987	91.2	91.5	90.5	0.77	30.4	5.5	146.0	1.7	2.7	0.225	175	59
18.5	M3AA 200MLA 6	3GAA203410-**K	990	91.7	92.1	91.5	0.77	37.3	7.5	178.0	2.6	3.2	0.448	218	63
22	M3AA 200MLB 6	3GAA203420-**K	990	92.2	92.7	92.0	0.79	43	7.8	212.0	2.6	3.2	0.531	245	63
30	M3AA 225SMA 6	3GAA223210-**K	989	92.9	93.6	93.3	0.81	56.8	7.9	289.0	2.8	3.1	0.813	310	63
37	M3AA 250SMA 6	3GAA253210-**K	991	93.3	93.9	93.6	0.83	68	7.7	356.0	2.7	2.9	1.49	367	63

Output kW	Motor type	Product code	Speed r/min	Efficiency IEC 60034-30-1: 2014			Power factor Cos ϕ	Current		Torque		Moment of inertia J = 1/4 GD ² kgm ²	Weight kg	Sound pressure Level L _{PA} dB	
				Full load 100%	3/4 load 75%	1/2 load 50%		I _N A	I _S /I _N	T _N Nm	T _I /T _N				T _B /T _N
1000 r/min = 6 poles			400 V 50 Hz					High-output design							
18.5	M3AA 180MLB 6	3GAA183420-**K	980	91.7	92.1	91.5	0.72	40.3	6.8	180	2.3	3.2	0.191	168	65
37	M3AA 225SMB 6	3GAA223220-**K	985	93.3	93.6	93.0	0.80	71.5	7.0	358.7	2.7	3.0	0.813	307	68
45	M3AA 250SMB 6	3GAA253220-**K	991	93.7	93.8	93.1	0.79	87.3	8.0	433.2	3.1	3.2	1.33	389	68

Technical data, 400 V 50 Hz

IE2 Process performance aluminum motors

IP 55 - IC 411 - Insulation class F, temperature rise class B
IE2 efficiency class according to IEC 60034-30-1: 2014

Output kW	Motor type	Product code	Speed r/min	Efficiency IEC 60034-30-1: 2014			Power factor Cos ϕ	Current		Torque		Moment of inertia J = 1/4 GD ² kgm ²	Weight kg	Sound pressure Level L _{PA} dB	
				Full load 100%	3/4 load 75%	1/2 load 50%		I _N A	I _S /I _N	T _N Nm	T _I /T _N				T _B /T _N
3000 r/min = 2 poles				400 V 50 Hz				CENELEC-design							
0.09	M3AA 56A 2	3GAA051311---F	2800	55.6	50.8	38.7	0.67	0.35	3.5	0.29	2.4	2.6	0.0001	2.8	56
0.12	M3AA 56B 2	3GAA051312---F	2830	53.6	49.3	37.2	0.68	0.41	4.3	0.4	2.5	2.8	0.00013	2.9	57
0.18	M3AA 63A 2	3GAA061311---F	2790	60.4	57.8	49.5	0.75	0.51	4.5	0.61	2.4	2.6	0.00015	3.7	60
0.25	M3AA 63B 2	3GAA061312---F	2790	64.8	63.2	56.7	0.76	0.66	4.8	0.86	2.8	2.7	0.00017	4.1	61
0.37	M3AA 71A 2	3GAA071311---E	2785	69.5	70.8	67.8	0.79	0.91	4.6	1.26	2.5	2.8	0.0004	4.9	58
0.55	M3AA 71B 2	3GAA071312---E	2790	74.1	75.4	73.4	0.79	1.29	5.1	1.88	3.1	3.1	0.0005	5.9	58
0.75	M3AA 80B 2	3GAA081312---E	2895	80.6	80.4	77.3	0.79	1.7	8.1	2.4	3.7	3.9	0.0009	10.5	60
1.1	M3AA 80C 2	3GAA081313---E	2875	80.6	80.4	77.9	0.80	2.4	7.8	3.6	3.6	3.5	0.0012	11	60
1.5	M3AA 90L 2	3GAA091500---E	2900	84.1	85.0	83.5	0.86	2.9	7.6	4.9	2.5	3.3	0.0024	16	60
2.2	M3AA 90LB 2	3GAA091520---E	2870	84.6	85.7	85.0	0.86	4.4	6.9	7.3	2.8	3.2	0.0027	18	63
3	M3AA 100LB 2	3GAA101520---E	2920	86.4	86.1	84.0	0.86	5.8	9.3	9.8	3.3	3.9	0.005	25	62
4	M3AA 112MB 2	3GAA111320---E	2885	86.1	87.0	88.0	0.88	7.6	7.6	13.2	2.5	2.8	0.0062	30	68
5.5	M3AA 132SB 2	3GAA131120---E	2915	88.0	88.2	86.9	0.82	11	7.9	18	2.6	3.6	0.016	52	73
7.5	M3AA 132SC 2	3GAA131130---E	2915	88.5	89.2	88.6	0.88	13.6	7.6	24.5	2.2	3.2	0.022	52	73
11	M3AA 160MLA 2	3GAA161410---G	2938	90.6	91.5	91.1	0.90	19.2	7.5	35.7	2.4	3.1	0.044	91	69
15	M3AA 160MLB 2	3GAA161420---G	2934	91.5	92.5	92.2	0.90	26	7.5	48.8	2.5	3.3	0.053	105	69
18.5	M3AA 160MLC 2	3GAA161430---G	2932	92.0	93.1	93.1	0.92	31.5	7.5	60.2	2.9	3.4	0.063	123	69
22	M3AA 180MLA 2	3GAA181410---G	2952	92.2	92.8	92.2	0.87	39.5	7.7	71.1	2.8	3.3	0.076	132	69
30	²⁾ M3AA 200MLA 2	3GAA201410---G	2956	93.1	93.5	92.8	0.90	51.4	7.7	96.9	2.7	3.1	0.178	210	72
37	M3AA 200MLB 2	3GAA201420---G	2959	93.4	93.7	92.9	0.90	63.5	8.2	119	3.0	3.3	0.196	225	72
45	M3AA 225SMA 2	3GAA221210---G	2961	93.6	93.9	93.1	0.88	78.8	6.7	145	2.5	2.5	0.244	263	74
55	M3AA 250SMA 2	3GAA251210---G	2967	94.1	94.4	93.8	0.88	95.8	6.8	177	2.2	2.7	0.507	304	75

²⁾ Temperature rise class F

Technical data, 400 V 50 Hz

IE2 Process performance aluminum motors

IP 55 - IC 411 - Insulation class F, temperature rise class B
IE2 efficiency class according to IEC 60034-30-1: 2014

Output kW	Motor type	Product code	Speed r/min	Efficiency IEC 60034-30-1: 2014			Power factor Cos ϕ	Current		Torque		Moment of inertia J = 1/4 GD ² kgm ²	Weight kg	Sound pressure Level L _{PA} dB	
				Full load 100%	3/4 load 75%	1/2 load 50%		I _N A	I _S /I _N	T _N Nm	T _I /T _N				T _B /T _N
3000 r/min = 2 poles			400 V 50 Hz					High-output design							
0.37	M3AA 63C 2	3GAA061313-**-F	2750	69.5	68.8	63.2	0.78	0.96	4.7	1.28	2.8	2.6	0.0002	4.6	59
11	M3AA 132SMF 2	3GAA131260-**-E	2900	90.3	90.5	89.4	0.87	20.2	8.5	36.2	2.7	3.7	0.0186	77	68
15	M3AA 132SMG 2	3GAA131270-**-E	2905	90.4	90.8	90.0	0.84	28.5	9.1	49.3	3.3	4.0	0.02	81	69
18.5	M3AA 132SMJ 2	3GAA131290-**-E	2895	91.1	92.0	92.1	0.89	32.9	9.7	61	3.2	4.3	0.0256	93	68
22	M3AA 160MLD 2	3GAA161440-**-G	2933	91.7	92.8	92.8	0.90	38	8.1	71.6	3.2	3.6	0.063	123	69
27	M3AA 160MLE 2	3GAA161450-**-G	2939	92.2	93.1	93.1	0.90	46.4	8.8	87.7	3.4	3.8	0.072	145	69
30	²⁾ M3AA 180MLB 2	3GAA181420-**-G	2950	92.7	93.5	93.3	0.88	53	7.9	97.1	2.8	3.3	0.092	149	69
45	²⁾ M3AA 200MLC 2	3GAA201430-**-G	2957	93.3	93.8	93.2	0.90	78.2	8.1	145	3.1	3.3	0.196	225	72
55	²⁾ M3AA 200MLD 2	3GAA201440-**-G	2953	93.8	94.5	94.3	0.89	95	7.8	177	2.9	3.3	0.217	241	72
55	M3AA 225SMB 2	3GAA221220-**-G	2961	93.9	94.3	93.6	0.88	96	6.5	177	2.4	2.5	0.274	286	74
75	²⁾ M3AA 225SMC 2	3GAA221230-**-G	2969	94.4	94.6	94.0	0.84	136	7.4	241	3.2	3.1	0.309	312	74
75	²⁾ M3AA 225SMD 2	3GAA221240-**-G	2967	94.4	94.6	94.0	0.87	131	7.7	241	3.2	3.0	0.329	317	74
75	²⁾ M3AA 250SMB 2	3GAA251220-**-G	2970	94.5	94.8	94.3	0.89	128	7.6	241	2.8	3.1	0.583	351	75
80	²⁾ M3AA 225SMD 2	3GAA221240-**-G	2964	94.4	94.8	94.3	0.87	140	7.3	257	3.0	2.8	0.329	317	74
90	²⁾ M3AA 250SMC 2	3GAA251230-**-G	2971	95.0	95.3	94.9	0.89	153	7.6	289	2.5	3.1	0.644	386	75

²⁾ Temperature rise class F

Technical data, 400 V 50 Hz

IE2 Process performance aluminum motors

IP 55 - IC 411 - Insulation class F, temperature rise class B
IE2 efficiency class according to IEC 60034-30-1: 2014

Output kW	Motor type	Product code	Speed r/min	Efficiency IEC 60034-30-1: 2014			Power factor Cos ϕ	Current		Torque		Moment of inertia J = 1/4 GD ² kgm ²	Weight kg	Sound pressure Level L _{PA} dB	
				Full load 100%	3/4 load 75%	1/2 load 50%		I _N A	I _S /I _N	T _N Nm	T _I /T _N				T _B /T _N
1500 r/min = 4 poles			400 V 50 Hz					CENELEC-design							
0.06	M3AA 56A 4	3GAA052311--F	1390	52.8	49.6	40.8	0.54	0.3	3.2	0.41	3.2	3.3	0.00019	2.9	47
0.09	M3AA 56B 4	3GAA052312--F	1400	56.2	52.6	44.8	0.59	0.39	3.1	0.62	2.3	2.8	0.00024	3.2	48
0.12	M3AA 63A 4	3GAA062311--F	1403	59.1	55.8	47.1	0.63	0.41	2.9	0.82	2.2	2.4	0.0003	3.7	51
0.18	M3AA 63B 4	3GAA062312--F	1380	64.7	62.8	55.9	0.68	0.58	3.6	1.25	2.0	2.4	0.00034	4.4	54
0.25	M3AA 71A 4	3GAA072311--E	1430	68.5	66.8	59.9	0.67	0.76	4.7	1.67	2.2	3.0	0.0006	5.2	45
0.37	M3AA 71B 4	3GAA072312--E	1375	69.7	71.9	71.1	0.79	0.96	3.8	2.5	2.0	2.2	0.0008	5.9	45
0.55	M3AA 80A 4	3GAA082311--E	1406	77.1	78.6	76.8	0.78	1.29	6.4	3.73	2.8	2.9	0.0022	8.5	50
0.75	M3AA 80E 4	3GAA082315--E	1425	79.8	80.4	77.9	0.72	1.88	6.6	5	3.5	3.6	0.002	15	54
1.1	M3AA 90LB 4	3GAA092520--E	1435	83.7	83.7	81.7	0.78	2.4	6.6	7.3	2.9	3.2	0.0043	16	50
1.5	M3AA 90LD 4	3GAA092540--E	1435	84.2	84.1	81.9	0.76	3.3	7.0	9.9	3.1	3.5	0.0048	17	50
2.2	M3AA 100LC 4	3GAA102530--E	1450	86.4	86.2	84.1	0.79	4.6	7.3	14.4	2.8	3.4	0.009	25	54
3	M3AA 100LD 4	3GAA102540--E	1445	85.7	86.1	85.1	0.79	6.3	7.0	19.8	2.4	3.0	0.011	28	63
4	M3AA 112MB 4	3GAA112320--E	1445	86.7	86.5	85.2	0.75	8.8	7.3	26.4	3.1	3.4	0.0126	34	64
5.5	M3AA 132M 4	3GAA132300--E	1465	89.0	89.5	88.6	0.79	10.9	6.3	36	1.9	2.6	0.038	48	66
7.5	M3AA 132MA 4	3GAA132310--E	1460	88.7	89.5	89.0	0.79	14.7	6.4	49	1.8	2.6	0.048	59	63
11	M3AA 160MLA 4	3GAA162410--G	1466	90.4	91.6	91.4	0.84	20.9	6.8	71.6	2.2	2.8	0.081	99	62
15	M3AA 160MLB 4	3GAA162420--G	1470	91.4	92.4	92.2	0.83	28.5	7.1	97.4	2.6	3.0	0.099	118	62
18.5	M3AA 180MLA 4	3GAA182410--G	1477	91.9	92.9	92.7	0.84	34.5	7.2	119	2.6	2.9	0.166	146	62
22	M3AA 180MLB 4	3GAA182420--G	1475	92.3	93.3	93.2	0.84	40.9	7.3	142	2.6	3.0	0.195	163	62
30	M3AA 200MLA 4	3GAA202410--G	1480	93.2	94.0	93.7	0.84	55.2	7.4	193	2.8	3.0	0.309	218	63
37	M3AA 225SMA 4	3GAA222210--G	1479	93.4	93.9	93.4	0.84	68	7.1	238	2.6	2.9	0.356	240	66
45	M3AA 225SMB 4	3GAA222220--G	1480	93.9	94.3	93.9	0.85	81.3	7.5	290	2.8	3.2	0.44	273	66
55	M3AA 250SMA 4	3GAA252210--G	1480	94.4	94.9	94.6	0.85	98.9	7.0	354	2.6	2.9	0.765	314	67

²⁾ Temperature rise class F

Technical data, 400 V 50 Hz

IE2 Process performance aluminum motors

IP 55 - IC 411 - Insulation class F, temperature rise class B
IE2 efficiency class according to IEC 60034-30-1: 2014

Output kW	Motor type	Product code	Speed r/min	Efficiency IEC 60034-30-1: 2014			Power factor Cos ϕ	Current		Torque		Moment of inertia J = 1/4 GD ² kgm ²	Weight kg	Sound pressure Level L _{PA} dB	
				Full load 100%	3/4 load 75%	1/2 load 50%		I _N A	I _s /I _N	T _N Nm	T _i /T _N				T _b /T _N
1500 r/min = 4 poles			400 V 50 Hz				High-output design								
0.25	M3AA 63C 4	3GAA062313...F	1374	68.5	68.8	64.6	0.70	0.70	3.1	1.7	2.2	2.4	0.0004	5	55
9.2	M3AA 132MF 4	3GAA132360...E	1460	89.8	90.8	90.2	0.79	18.7	7.3	60.1	2.2	3.4	0.048	59	59
11	M3AA 132SMF 4	3GAA132260...E	1460	90.4	90.8	89.9	0.79	21.5	7.7	71.9	2.1	3.1	0.0433	83	65
15	²⁾ M3AA 132SMH 4	3GAA132280...E	1455	90.6	91.0	90.3	0.77	29.8	7.1	98.4	2.4	2.9	0.0517	82	67
18.5	M3AA 160MLC 4	3GAA162430...G	1469	91.4	92.5	92.3	0.84	34.7	7.6	120	3.0	3.2	0.11	127	62
22	²⁾ M3AA 160MLD 4	3GAA162440...G	1464	91.6		92.7	0.85	41.3	6.9	143	2.5	2.9	0.125	140	62
30	²⁾ M3AA 180MLC 4	3GAA182430...G	1474	92.3	93.5	93.5	0.83	56.5	7.3	194	2.7	2.9	0.217	177	62
37	M3AA 200MLB 4	3GAA202420...G	1479	93.4	94.4	94.4	0.85	67.2	7.1	238	2.6	2.9	0.343	234	63
45	²⁾ M3AA 200MLC 4	3GAA202430...G	1479	93.6	94.4	94.2	0.83	83.6	7.5	290	2.9	3.2	0.366	246	63
55	²⁾ M3AA 225SMC 4	3GAA222230...G	1478	94.0	94.7	94.5	0.85	99.3	7.4	355	2.9	3.1	0.474	287	66
64	M3AA 225SMD 4	3GAA222240...G	1480	94.2	94.6	94.1	0.85	115	8.2	412	3.3	3.3	0.542	314	66
75	²⁾ M3AA 250SMB 4	3GAA252220...G	1478	94.4	95.1	94.8	0.85	134	7.3	484	2.8	3.1	0.866	350	67
90	²⁾ M3AA 250SMC 4	3GAA252230...G	1478	94.6	95.3	95.0	0.84	163	7.4	581	3.1	3.3	0.941	377	67

²⁾ Temperature rise class F

Technical data, 400 V 50 Hz

IE2 Process performance aluminum motors

IP 55 - IC 411 - Insulation class F, temperature rise class B
IE2 efficiency class according to IEC 60034-30-1: 2014

Output kW	Motor type	Product code	Speed r/min	Efficiency IEC 60034-30-1: 2014			Power factor Cos ϕ	Current		Torque		Moment of inertia J = 1/4 GD ² kgm ²	Weight kg	Sound pressure Level L _{PA} dB	
				Full load 100%	3/4 load 75%	1/2 load 50%		I _N A	I _S /I _N	T _N Nm	T _I /T _N				T _B /T _N
1000 r/min = 6 poles															
400 V 50 Hz															
CENELEC-design															
0.09	M3AA 63A 6	3GAA063311...F	890	50.7	48.5	42.0	0.62	0.41	2.8	0.96	2.0	2.2	0.00042	4.2	48
0.12	M3AA 63B 6	3GAA063312...F	890	50.6	46.8	39.3	0.60	0.55	3.0	1.29	2.2	2.4	0.00052	4.5	53
0.18	M3AA 71A 6	3GAA073311...E	870	56.6	58.7	54.8	0.71	0.61	2.8	1.97	1.9	2.0	0.0009	5.5	42
0.25	M3AA 71B 6	3GAA073312...E	890	61.6	61.8	56.7	0.68	0.84	3.1	2.68	2.3	2.4	0.0012	6.5	42
0.37	M3AA 80A 6	3GAA083311...E	923	67.6	67.5	62.6	0.73	1.04	4.4	3.82	2.6	2.8	0.0019	9	47
0.75	M3AA 90LB 6	3GAA093520...E	930	77.6	78.0	75.6	0.71	1.96	4.0	7.7	2.0	2.3	0.0048	18	44
1.1	M3AA 90LD 6	3GAA093540...E	935	78.2	79.2	77.5	0.66	2.94	4.2	11.2	2.2	2.6	0.0056	20	44
1.5	M3AA 100LC 6	3GAA103530...E	945	80.3	81.4	80.7	0.73	3.6	3.9	15.1	1.7	2.0	0.009	26	49
2.2	M3AA 112MB 6	3GAA113320...E	955	81.9	81.8	79.2	0.72	5.3	5.2	21.9	1.8	2.2	0.01	34	56
3	M3AA 132S 6	3GAA133100...E	960	83.3	82.9	80.5	0.65	7.69	4.3	29.8	1.6	2.3	0.031	46	57
4	M3AA 132MB 6	3GAA133320...E	975	86.4	85.8	83.1	0.70	9.4	7.3	39.2	2.1	4.4	0.045	54	57
5.5	M3AA 132MC 6	3GAA133330...E	965	86.1	85.6	83.0	0.67	13.3	6.2	54.3	2.5	2.8	0.049	59	61
7.5	M3AA 160MLA 6	3GAA163410...G	975	88.5	89.8	89.7	0.79	15.4	7.4	73.4	1.7	3.2	0.087	98	59
11	M3AA 160MLB 6	3GAA163420...G	972	89.3	90.6	90.5	0.79	22.5	7.5	108	1.9	2.9	0.114	125	59
15	M3AA 180MLA 6	3GAA183410...G	977	90.5	91.5	91.0	0.77	31	5.8	146	1.8	2.7	0.168	148	59
18.5	M3AA 200MLA 6	3GAA203410...G	988	91.6	92.3	91.7	0.80	36.4	6.7	178	2.3	2.9	0.382	196	63
22	M3AA 200MLB 6	3GAA203420...G	987	92.0	92.9	92.8	0.82	42	6.6	212	2.2	2.8	0.448	218	63
30	M3AA 225SMA 6	3GAA223210...G	986	92.6	93.3	92.8	0.83	56.2	7.0	290	2.6	2.9	0.663	266	63
37	M3AA 250SMA 6	3GAA253210...G	989	93.1	93.8	93.4	0.82	69.9	6.8	357	2.4	2.7	1.13	294	63

²⁾ Temperature rise class F

Output kW	Motor type	Product code	Speed r/min	Efficiency IEC 60034-30-1: 2014			Power factor Cos ϕ	Current		Torque		Moment of inertia J = 1/4 GD ² kgm ²	Weight kg	Sound pressure Level L _{PA} dB	
				Full load 100%	3/4 load 75%	1/2 load 50%		I _N A	I _S /I _N	T _N Nm	T _I /T _N				T _B /T _N
1000 r/min = 6 poles															
400 V 50 Hz															
High-output design															
0.18	M3AA 63C 6	3GAA063313...F	880	56.6	55.4	49.1	0.62	0.72	2.8	1.96	2.1	2.2	0.0006	5.3	45
15	M3AA 160MLC 6	3GAA163430...G	971	89.7	91.2	91.2	0.77	31.3	7.3	147	1.8	3.6	0.131	138	59
18.5	M3AA 180MLB 6	3GAA183420...G	975	90.7	92.0	92.0	0.79	37.2	5.8	181	1.7	2.7	0.198	162	59
30	²⁾ M3AA 200MLC 6	3GAA203430...G	985	92.0	93.1	92.9	0.83	56.7	6.9	290	2.3	2.8	0.531	245	63
37	M3AA 225SMB 6	3GAA223220...G	985	93.1	94.0	94.0	0.83	69.1	6.6	358	2.3	2.6	0.821	300	63
45	²⁾ M3AA 225SMC 6	3GAA223230...G	984	92.6	93.9	94.0	0.83	84.4	6.4	436	2.3	2.6	0.821	300	63
45	²⁾ M3AA 250SMB 6	3GAA253220...G	989	93.4	94.1	93.9	0.83	83.7	7.0	434	2.5	2.7	1.37	341	63
55	²⁾ M3AA 250SMC 6	3GAA253230...G	988	93.2	94.1	94.0	0.84	101	7.1	531	2.6	2.8	1.5	367	63

²⁾ Temperature rise class F

Technical data, 460 V 60 Hz

IE3 Process performance aluminum motors

IP 55 - IC 411 - Insulation class F, temperature rise class B
IE3 efficiency class according to IEC 60034-30-1: 2014

Output	Motor type	Product code	Speed r/min	Efficiency IEC 60034-30-1: 2014			Power factor Cos ϕ	Current		Torque		Moment of inertia J = 1/4 GD ² kgm ²	Weight kg	Sound pressure Level L _{PA} dB	
				Full load 100%	3/4 load 75%	1/2 load 50%		I _N A	I _S /I _N	T _N Nm	T _I /T _N				T _B /T _N
3600 r/min = 2 poles			460 V 60 Hz						CENELEC-design						
0.75	M3AA 80MB 2	3GAA081320---K	3502	77.0	75.1	69.9	0.72	1.56	8.9	2.0	4.3	5.2	0.0008	9.5	61
1.1	M3AA 80MC 2	3GAA081330---K	3500	84.0	83.0	80.2	0.78	2.0	9.9	3.0	4.4	5.3	0.001	10.5	60
1.5	M3AA 90LB 2	3GAA091520---K	3522	85.5	85.3	84.0	0.88	2.4	9.6	4.0	4.0	4.6	0.0027	17	65
2.2	M3AA 90LC 2	3GAA091530---K	3517	86.5	87.1	85.8	0.88	3.5	9.9	5.9	3.1	4.2	0.0032	20	65
3	M3AA 100LC 2	3GAA101530---K	3512	88.5	88.7	87.2	0.89	4.7	9.9	8.1	3.5	4.6	0.0057	28	65
4	M3AA 112MB 2	3GAA111320---K	3500	88.5	88.9	87.9	0.90	6.2	10.0	10.9	3.6	4.8	0.0104	38	71
5.5	M3AA 132SB 2	3GAA131120---K	3519	89.5	89.4	88.7	0.90	8.4	9.1	14.9	2.5	3.9	0.0154	58	74
7.5	M3AA 132SC 2	3GAA131130---K	3524	90.2	90.7	90.0	0.90	11.4	9.6	20.3	3.1	4.5	0.0173	63	73
11	M3AA 160MLA 2	3GAA161410---K	3549	91.0	91.1	89.9	0.91	16.6	8.7	29.5	2.7	3.9	0.057	106	75
15	M3AA 160MLB 2	3GAA161420---K	3554	91.0	90.4	89.6	0.89	23.2	8.5	40.3	3.8	4.8	0.063	123	74
18.5	M3AA 160MLC 2	3GAA161430---K	3555	91.7	91.9	90.7	0.89	28.4	10.5	49.7	3.8	4.7	0.076	137	75
22	M3AA 180MLA 2	3GAA181410---K	3560	91.7	91.7	90.4	0.89	33	9.2	59.0	4.1	4.7	0.11	176	77
30	M3AA 200MLA 2	3GAA201410---K	3567	92.4	92.2	91.0	0.87	46.1	9.0	80.3	3.2	4.0	0.159	225	76
37	M3AA 200MLB 2	3GAA201420---K	3564	93.0	92.8	91.2	0.88	56.7	9.2	99.1	3.1	3.7	0.196	241	76
45	M3AA 225SMA 2	3GAA221210---K	3570	93.6	93.1	91.5	0.89	67.4	7.8	120	3.3	3.7	0.296	326	79
55	M3AA 250SMA 2	3GAA251210---K	3569	93.6	93.1	91.6	0.90	82.7	7.9	147	2.3	3.3	0.426	351	81

Output kW	Motor type	Product code	Speed r/min	Efficiency IEC 60034-30-1: 2014			Power factor Cos ϕ	Current		Torque		Moment of inertia J = 1/4 GD ² kgm ²	Weight kg	Sound pressure Level L _{PA} dB	
				Full load 100%	3/4 load 75%	1/2 load 50%		I _N A	I _S /I _N	T _N Nm	T _I /T _N				T _B /T _N
3600 r/min = 2 poles			460 V 60 Hz						High-output design						
2.75	M3AA 90LD 2	3GAA091540---K	3497	86.5	87.4	86.3	0.82	4.69	7.1	8.0	4.2	5.1	0.00407	20	69
4	M3AA 100LD 2	3GAA101540---K	3523	88.5	89.4	88.5	0.91	6.2	10.9	10.8	5.0	5.4	0.00787	40	71
5.5	M3AA 112MC 2	3GAA111330---K	3523	89.5	88.1	87.1	0.89	8.4	11.2	15.0	5.4	6.8	0.0132	48	77
9.2	M3AA 132SD 2	3GAA131140---K	3525	90.2	90.4	89.3	0.90	13.9	9.1	24.9	4.0	4.8	0.0168	71	79
11	M3AA 132SME 2	3GAA131250---K	3527	91.0	90.8	89.3	0.89	16.7	12.1	29.8	4.7	6.2	0.0231	90	79
15	M3AA 132SMF 2	3GAA131260---K	3526	91.0	91.6	91.2	0.90	22.3	10.5	40.9	3.8	5.1	0.023	90	79
22	M3AA 160MLD 2	3GAA161440---K	3552	92.9	93.2	92.5	0.90	32.9	9.7	59.2	3.5	4.2	0.071	131	78
30	M3AA 180MLB 2	3GAA181420---K	3563	93.3	93.5	92.9	0.88	45.7	10.0	80.4	3.3	4.3	0.104	162	78
37	M3AA 180MLC 2	3GAA181430---K	3564	93.0	93.2	92.7	0.86	57	9.7	99.1	3.8	4.7	0.117	176	78
45	M3AA 200MLC 2	3GAA201430---K	3563	93.6	93.9	93.7	0.89	66.8	8.7	120.6	3.2	3.7	0.216	250	81
55	M3AA 225SMB 2	3GAA221220---K	3575	93.6	93.6	92.7	0.86	84.5	8.1	146.9	3.41	3.72	0.299	288	83
75	M3AA 225SMC 2	3GAA221230---K	3572	94.1	94.3	93.5	0.88	114	8.4	200.7	3.24	3.75	0.361	328	83
75	M3AA 250SMB 2	3GAA251220---K	3575	94.9	94.9	94.1	0.90	110	9.0	200.3	3.0	3.6	0.644	405	85
90	M3AA 250SMC 2	3GAA251230---K	3578	95.0	94.9	94.1	0.87	136	9.6	240	3.08	4.17	0.514	414	85

Technical data, 460 V 60 Hz

IE3 Process performance aluminum motors

IP 55 - IC 411 - Insulation class F, temperature rise class B
IE3 efficiency class according to IEC 60034-30-1: 2014

Output kW	Motor type	Product code	Speed r/min	Efficiency IEC 60034-30-1; 2014			Power factor Cos ϕ	Current		Torque		Moment of inertia J = 1/4 GD ² kgm ²	Weight kg	Sound pressure Level L _{PA} dB	
				Full load 100%	3/4 load 75%	1/2 load 50%		I _N A	I _s /I _N	T _N Nm	T _i /T _N				T _b /T _N
1800 r/min = 4 poles															
460 V 60 Hz															
CENELEC-design															
0.75	M3AA 80ME 4	3GAA082350---K	1748	83.5	82.2	79.0	0.74	1.48	9.5	4.0	3.8	4.5	0.0027	13.5	57
1.1	M3AA 90LC 4	3GAA092530---K	1749	86.5	85.4	82.5	0.77	2.0	8.4	6.0	3.7	4.6	0.0055	19	56
1.5	M3AA 90LD 4	3GAA092540---K	1748	86.5	85.1	82.0	0.75	2.9	9.5	8.1	4.0	5.0	0.0055	19	57
2.2	M3AA 100LE 4	3GAA102550---K	1760	89.5	89.2	87.4	0.81	3.8	10.2	11.9	3.3	4.7	0.0144	36	57
3	M3AA 100LF 4	3GAA102560---K	1759	89.5	89.3	87.4	0.81	5.2	10.4	16.3	3.8	4.9	0.0144	36	57
4	M3AA 112MB 4	3GAA112320---K	1755	90.1	90.5	89.5	0.75	7.43	9.3	21.74	3.46	4.91	0.018	44	62
5.5	M3AA 132MB 4	3GAA132320---K	1769	91.7	91.7	90.5	0.75	10	8.0	29.7	3.0	4.5	0.0295	68	73
7.5	M3AA 132MC 4	3GAA132330---K	1766	91.7	91.6	90.8	0.79	13	8.7	40.5	2.6	3.9	0.0414	68	69
11	M3AA 160MLA 4	3GAA162410---K	1780	92.4	92.2	90.9	0.80	18.9	8.7	59.1	3.4	3.7	0.11	126	68
15	M3AA 160MLB 4	3GAA162420---K	1777	93.0	92.6	91.2	0.79	25.7	8.9	80.6	3.3	4.1	0.135	140	67
18.5	M3AA 180MLA 4	3GAA182410---K	1783	93.6	93.7	92.9	0.82	30.3	8.4	99.0	3.1	3.5	0.219	177	68
22	M3AA 180MLB 4	3GAA182420---K	1783	93.8	94.2	93.7	0.82	35.8	9.3	117.0	3.0	3.4	0.217	176	66
30	M3AA 200MLA 4	3GAA202410---K	1783	94.1	94.0	93.0	0.83	48.2	8.5	160.6	2.8	3.9	0.385	246	69
37	M3AA 225SMA 4	3GAA222210---K	1786	94.5	94.4	93.5	0.81	61.2	8.4	195.2	3.8	4.0	0.433	315	65
45	M3AA 225SMB 4	3GAA222220---K	1784	95.0	94.9	95.0	0.83	71.8	8.8	241.2	2.9	4.7	0.525	316	72
55	M3AA 250SMA 4	3GAA252210---K	1787	95.7	95.8	95.2	0.84	85.8	9.1	293.0	3.3	3.7	0.933	376	71

Output kW	Motor type	Product code	Speed r/min	Efficiency IEC 60034-30-1; 2014			Power factor Cos ϕ	Current		Torque		Moment of inertia J = 1/4 GD ² kgm ²	Weight kg	Sound pressure Level L _{PA} dB	
				Full load 100%	3/4 load 75%	1/2 load 50%		I _N A	I _s /I _N	T _N Nm	T _i /T _N				T _b /T _N
1800 r/min = 4 poles															
460 V 60 Hz															
High-output design															
5.5	M3AA 112MC 4	3GAA112330---K	1762	91.7	91.3	89.3	0.75	10	10.1	29.9	4.3	5.0	0.0234	50	66
9.2	M3AA 132MD 4	3GAA132340---K	1770	91.7	91.8	90.9	0.78	15.9	9.5	49.6	3.3	4.6	0.0392	65	77
11	M3AA 132SME 4	3GAA132250---K	1771	92.4	92.6	91.7	0.78	18.9	9.3	59.4	3.4	4.5	0.0468	88	77
15	M3AA 132SMF 4	3GAA132260---K	1769	93.0	93.2	92.2	0.78	25.8	9.9	80.9	3.7	5.2	0.0545	88	77
18.5	M3AA 160MLC 4	3GAA162430---K	1778	93.6	93.6	92.7	0.76	32.4	8.2	99.3	3.8	4.0	0.12	135	71
28	M3AA 180MLC 4	3GAA182430---K	1784	94.1	93.7	92.4	0.79	50.8	9.2	160.59	3.12	3.77	0.191	176	65
37	M3AA 200MLB 4	3GAA202420---K	1785	94.5	94.3	93.4	0.81	60.5	9.1	198.2	3.5	3.6	0.362	244	68
49	M3AA 225SMC 4	3GAA222230---K	1787	95	94.8	93.8	0.85	78.9	10.7	261.84	3.79	4.13	0.532	318	75
75	M3AA 250SMB 4	3GAA252220---K	1785	95.4	95.4	94.7	0.81	121	8.5	402.8	3.75	3.7	0.796	389	77

Technical data, 460 V 60 Hz

IE3 Process performance aluminum motors

IP 55 - IC 411 - Insulation class F, temperature rise class B
IE3 efficiency class according to IEC 60034-30-1: 2014

Output kW	Motor type	Product code	Speed r/min	Efficiency IEC 60034-30-1: 2014			Power factor Cos ϕ	Current			Torque		Moment of inertia J = 1/4 GD ² kgm ²	Weight kg	Sound pressure Level L _{PA} dB
				Full load 100%	3/4 load 75%	1/2 load 50%		I _N A	I _S /I _N	T _N Nm	T _I /T _N	T _B /T _N			
1200 r/min = 6 poles			460 V 60 Hz						CENELEC-design						
0.75	M3AA 90LD 6	3GAA093540-...K	1148	82.5	81.8	78.3	0.73	1.56	5.1	6.2	2.2	2.8	0.0055	19	61
1.1	M3AA 100LE 6	3GAA103550-...K	1168	87.5	87.5	85.8	0.66	2.3	6.3	9.0	2.4	3.5	0.0138	35	52
1.5	M3AA 100LF 6	3GAA103560-...K	1174	88.5	87.1	83.7	0.62	3.3	7.7	12.2	3.5	4.7	0.0138	35	52
2.2	M3AA 112MC 6	3GAA113330-...K	1172	89.5	89.6	88.4	0.66	4.6	7.3	17.9	2.5	4.0	0.0187	43	71
3	M3AA 132MC 6	3GAA133330-...K	1181	89.5	89.4	88.1	0.67	6.3	7.0	24.2	2.2	3.5	0.0402	66	64
4	M3AA 132MD 6	3GAA133340-...K	1176	89.5	89.9	88.9	0.69	8.0	6.2	32.4	2.0	3.0	0.0402	67	64
5.5	M3AA 132ME 6	3GAA133350-...K	1177	91.0	91.3	90.4	0.72	10.4	6.6	44.6	2.1	3.3	0.039	63	64
7.5	M3AA 160MLA 6	3GAA163410-...K	1182	91.4	91.5	90.3	0.76	13.5	8.6	60.5	1.8	3.7	0.114	125	63
11	M3AA 160MLB 6	3GAA163420-...K	1183	91.7	91.8	90.5	0.73	20.6	9.4	88.7	2.3	4.4	0.131	139	63
15	M3AA 180MLA 6	3GAA183410-...K	1189	92.3	92.0	90.5	0.75	27.1	6.0	120.0	1.8	3.1	0.225	175	63
18.5	M3AA 200MLA 6	3GAA203410-...K	1191	93.3	93.2	92.1	0.77	32.3	8.6	148.0	2.9	3.6	0.448	218	67
22	M3AA 200MLB 6	3GAA203420-...K	1191	93.8	93.8	92.8	0.78	37.7	8.8	176.0	2.9	3.6	0.531	245	67
30	M3AA 225SMA 6	3GAA223210-...K	1191	94.2	94.3	93.6	0.80	49.9	8.9	240.0	3.2	3.5	0.813	310	67
37	M3AA 250SMA 6	3GAA253210-...K	1192	94.5	94.7	94.1	0.82	59.9	8.6	296.0	3.0	3.2	1.49	367	67

Output kW	Motor type	Product code	Speed r/min	Efficiency IEC 60034-30-1: 2014			Power factor Cos ϕ	Current			Torque		Moment of inertia J = 1/4 GD ² kgm ²	Weight kg	Sound pressure Level L _{PA} dB
				Full load 100%	3/4 load 75%	1/2 load 50%		I _N A	I _S /I _N	T _N Nm	T _I /T _N	T _B /T _N			
1200 r/min = 6 poles			460 V 60 Hz				High-output design								
18.5	M3AA 180MLB 6	3GAA183420-...K	1183	93.0	93.0	92.1	0.69	36.1	8.2	149	2.6	3.7	0.197	168	69
37	M3AA 225SMB 6	3GAA223220-...K	1188	94.1	94.1	93.2	0.80	61.8	8.0	297.4	3.0	3.3	0.813	307	72
45	M3AA 250SMB 6	3GAA253220-...K	1193	94.5	94.4	93.4	0.77	77.5	8.3	361.7	3.4	3.9	1.33	389	72

Technical data, 460 V 60 Hz

IE2 Process performance aluminum motors

IP 55 - IC 411 - Insulation class F, temperature rise class B
IE2 efficiency class according to IEC 60034-30-1: 2014

Output kW	Motor type	Product code	Speed r/min	Efficiency IEC 60034-30-1: 2014			Power factor Cos ϕ	Current		Torque		Moment of inertia J = 1/4 GD ² kgm ²	Weight kg	Sound pressure Level L _{PA} dB	
				Full load 100%	3/4 load 75%	1/2 load 50%		I _N A	I _S /I _N	T _N Nm	T _I /T _N				T _B /T _N
3600 r/min = 2 poles				460 V 60 Hz				CENELEC-design							
0.09	M3AA 56A 2	3GAA051311---F	3430	56.8	50.6	40.5	0.60	0.33	3.9	0.23	3.0	3.3	0.0001	2.8	56
0.12	M3AA 56B 2	3GAA051312---F	3460	59.5	54.0	44.0	0.63	0.38	4.8	0.33	2.9	3.6	0.00013	2.9	57
0.18	M3AA 63A 2	3GAA061311---F	3420	64.0	60.2	51.4	0.70	0.46	5.3	0.5	3.0	3.4	0.00015	3.7	60
0.25	M3AA 63B 2	3GAA061312---F	3420	68.0	65.4	57.8	0.71	0.59	5.7	0.69	3.6	3.5	0.00017	4.1	61
0.37	M3AA 71A 2	3GAA071311---E	3425	72.0	71.4	66.6	0.75	0.8	5.8	1.03	3.0	3.5	0.0004	4.9	61
0.55	M3AA 71B 2	3GAA071312---E	3431	74.0	73.6	69.2	0.76	1.13	6.2	1.53	3.6	3.8	0.0005	5.9	61
0.75	M3AA 80B 2	3GAA081312---E	3505	82.5	81.4	77.5	0.80	1.43	9.6	2.0	3.7	4.5	0.0009	10.5	63
1.1	M3AA 80C 2	3GAA081313---E	3490	82.6	81.9	78.7	0.78	2.1	9.1	3.0	3.9	4.2	0.0012	11	63
1.5	M3AA 90L 2	3GAA091500---E	3510	85.1	85.0	82.9	0.84	2.6	8.4	4.0	2.8	3.8	0.0024	16	63
2.2	M3AA 90LB 2	3GAA091520---E	3480	85.8	85.9	84.2	0.85	3.7	7.9	6.0	2.6	3.7	0.0027	18	66
3	M3AA 100LB 2	3GAA101520---E	3530	87.5	86.8	84.6	0.84	5.1	10.0	8.1	4.1	4.6	0.005	25	65
4	M3AA 112MB 2	3GAA111320---E	3490	87.6	88.4	87.8	0.91	6.2	8.1	10.9	2.7	3.0	0.0062	30	71
5.5	M3AA 132SB 2	3GAA131120---E	3515	88.5	87.8	85.3	0.86	9.0	8.5	14.9	2.5	4.1	0.016	52	76
7.5	M3AA 132SC 2	3GAA131130---E	3525	89.5	89.2	87.6	0.89	12	8.7	20.3	2.3	3.7	0.022	52	76
11	M3AA 160MLA 2	3GAA161410---G	3547	91.4	91.5	90.3	0.90	16.7	8.6	29.6	2.6	3.5	0.044	91	73
15	M3AA 160MLB 2	3GAA161420---G	3545	92.1	92.3	91.2	0.90	22.4	8.7	40.4	2.7	3.8	0.053	105	73
18.5	M3AA 160MLC 2	3GAA161430---G	3543	92.4	92.8	92.1	0.92	27.2	8.7	49.8	3.1	3.8	0.063	123	73
22	M3AA 180MLA 2	3GAA181410---G	3559	92.4	92.4	91.1	0.87	34.3	8.8	59	3.0	3.8	0.076	132	73
30	M3AA 200MLA 2	3GAA201410---G	3562	93.1	92.8	91.4	0.90	44.9	8.7	80.4	2.8	3.4	0.178	210	76
37	M3AA 200MLB 2	3GAA201420---G	3564	93.4	93.2	91.7	0.89	55.8	9.2	99.1	3.1	3.7	0.196	225	76
45	M3AA 225SMA 2	3GAA221210---G	3566	93.5	93.2	91.7	0.88	68.6	7.7	120	2.6	2.7	0.244	263	78
55	M3AA 250SMA 2	3GAA251210---G	3571	93.8	93.5	92.1	0.88	83.2	7.7	147	2.3	3.0	0.507	304	79

²⁾ Temperature rise class F

Technical data, 460 V 60 Hz

IE2 Process performance aluminum motors

IP 55 - IC 411 - Insulation class F, temperature rise class B
IE2 efficiency class according to IEC 60034-30-1: 2014

Output kW	Motor type	Product code	Speed r/min	Efficiency IEC 60034-30-1: 2014			Power factor Cos ϕ	Current		Torque		Moment of inertia J = 1/4 GD ² kgm ²	Weight kg	Sound pressure Level L _{PA} dB	
				Full load 100%	3/4 load 75%	1/2 load 50%		I _N A	I _S /I _N	T _N Nm	T _I /T _N				T _B /T _N
3600 r/min = 2 poles			460 V 60 Hz						High-output design						
0.37 ²⁾	M3AA 63C 2	3GAA061313...F	3535	72.0	70.2	63.9	0.72	0.85	5.6	1.0	3.5	3.5	0.0002	4.6	59
11	M3AA 132SMF 2	3GAA131260...E	3504	90.9	90.3	88.3	0.94	17.2	9.0	30	2.8	4.3	0.0186	77	68
15	M3AA 132SMG 2	3GAA131270...E	3510	90.7	90.4	88.8	0.89	23.6	9.5	40.7	3.5	4.6	0.02	81	72
18.5	M3AA 132SMJ 2	3GAA131290...E	3500	91.6	91.8	90.9	0.91	28.2	10.5	50.3	3.3	5.3	0.0256	93	71
22	M3AA 160MLD 2	3GAA161440...G	3546	92.4	92.8	92.0	0.91	32.8	9.3	59.2	3.4	4.1	0.063	123	73
27	M3AA 160MLE 2	3GAA161450...G	3547	92.4	92.5	91.5	0.90	40.9	10.2	72.68	3.7	4.3	0.072	145	73
30	M3AA 180MLB 2	3GAA181420...G	3558	93.0	93.1	92.4	0.89	45.4	9.2	80.5	3.1	3.8	0.092	149	73
45	M3AA 200MLC 2	3GAA201430...G	3563	93.4	93.3	92.2	0.88	68.7	9.2	120	3.2	3.7	0.196	225	76
55	M3AA 200MLD 2	3GAA201440...G	3560	94.3	94.4	93.4	0.89	82.2	9.0	147	3.1	3.7	0.217	241	76
55	M3AA 225SMB 2	3GAA221220...G	3567	93.9	93.7	92.4	0.89	82.6	7.5	147	2.5	2.8	0.274	286	78
75	M3AA 225SMC 2	3GAA221230...G	3573	94.3	94.1	93.0	0.86	116	8.7	200	3.3	3.4	0.309	312	78
75	M3AA 250SMB 2	3GAA251220...G	3575	94.5	94.4	93.3	0.89	111	8.6	200	2.9	3.4	0.583	351	79
80	M3AA 225SMD 2	3GAA221240...G	3570	94.5	94.4	93.3	0.88	120	8.4	213	3.1	3.2	0.329	317	78
90	M3AA 250SMC 2	3GAA251230...G	3575	95.1	95.0	94.0	0.89	133	8.6	240	2.7	3.4	0.644	386	79

²⁾ Temperature rise class F

Technical data, 460 V 60 Hz

IE2 Process performance aluminum motors

IP 55 - IC 411 - Insulation class F, temperature rise class B
IE2 efficiency class according to IEC 60034-30-1: 2014

Output kW	Motor type	Product code	Speed r/min	Efficiency IEC 60034-30-1: 2014			Power factor Cos ϕ	Current		Torque		Moment of inertia J = 1/4 GD ² kgm ²	Weight kg	Sound pressure Level L _{PA} dB	
				Full load 100%	3/4 load 75%	1/2 load 50%		I _N A	I _S /I _N	T _N Nm	T _I /T _N				T _B /T _N
1800 r/min = 4 poles				460 V 60 Hz				CENELEC-design							
0.06	M3AA 56A 4	3GAA052311---F	1710	55.0	49.3	40.1	0.48	0.28	3.6	0.33	3.8	4.1	0.00019	2.9	47
0.09	M3AA 56B 4	3GAA052312---F	1720	58.6	53.5	44.8	0.52	0.37	3.3	0.5	3.0	3.6	0.00024	3.2	48
0.12	M3AA 63A 4	3GAA062311---F	1724	64.0	59.7	51.0	0.60	0.38	3.3	0.66	2.6	3.0	0.0003	3.7	51
0.18	M3AA 63B 4	3GAA062312---F	1700	68.0	65.4	57.7	0.62	0.53	3.5	1.0	2.5	3.0	0.00034	4.4	54
0.25 ¹⁾	M3AA 71A 4	3GAA072311---E	1685	69.3	68.7	64.0	0.68	0.66	4.8	1.41	2.3	2.7	0.00066	5.2	48
0.37	M3AA 71B 4	3GAA072312---E	1695	74.4	74.9	71.9	0.72	0.86	5.3	2.0	2.2	2.6	0.0008	5.9	48
0.55	M3AA 80A 4	3GAA082311---E	1695	77.7	78.7	76.6	0.74	1.2	5.5	3.0	2.0	2.8	0.0013	8.5	53
0.75	M3AA 80E 4	3GAA082315---E	1735	81.5	80.9	77.5	0.68	1.69	7.5	4.1	3.8	4.3	0.002	15	57
1.1	M3AA 90LB 4	3GAA092520---E	1740	84.6	83.7	80.7	0.76	2.1	7.6	6.0	3.1	3.9	0.0043	16	53
1.5	M3AA 90LD 4	3GAA092540---E	1750	85.4	84.1	80.6	0.72	3.0	8.2	8.1	3.8	4.6	0.0048	17	53
2.2	M3AA 100LC 4	3GAA102530---E	1760	87.5	86.9	84.2	0.75	4.2	9.1	11.9	3.4	4.5	0.009	25	57
3	M3AA 100LD 4	3GAA102540---E	1750	88.2	87.5	85.6	0.80	5.3	8.2	16.3	3.6	4.2	0.011	28	66
4	M3AA 112MB 4	3GAA112320---E	1745	87.6	87.5	85.7	0.77	7.4	8.2	21.8	3.3	3.7	0.0126	34	67
5.5	M3AA 132M 4	3GAA132300---E	1769	89.7	89.5	87.8	0.79	9.5	7.3	29.8	2.0	3.0	0.038	48	69
7.5	M3AA 132MA 4	3GAA132310---E	1764	89.5	89.6	88.3	0.81	12.8	7.5	40.6	1.9	3.0	0.048	59	66
11	M3AA 160MLA 4	3GAA162410---G	1772	91.3	91.6	90.5	0.83	18.2	7.7	59.2	2.4	3.2	0.081	99	66
15	M3AA 160MLB 4	3GAA162420---G	1775	92.2	92.4	91.5	0.83	24.6	8.0	80.6	2.7	3.3	0.099	118	66
18.5	M3AA 180MLA 4	3GAA182410---G	1781	92.5	92.8	91.9	0.83	30.2	8.2	99.1	2.8	3.2	0.166	146	66
22	M3AA 180MLB 4	3GAA182420---G	1780	93.1	93.4	92.5	0.83	35.7	8.3	118	2.8	3.3	0.195	163	66
30	M3AA 200MLA 4	3GAA202410---G	1783	93.8	94.0	93.1	0.83	48.2	8.4	160	3.0	3.3	0.309	218	67
37	M3AA 225SMA 4	3GAA222210---G	1782	93.6	93.5	92.5	0.84	59	8.1	198	2.8	3.2	0.356	240	70
45	M3AA 225SMB 4	3GAA222220---G	1784	94.2	94.1	93.1	0.85	70.5	8.6	240	2.7	3.3	0.44	273	70
55	M3AA 250SMA 4	3GAA252210---G	1782	95.2	95.4	94.9	0.84	86.3	8.0	294	2.8	3.3	0.765	314	71

¹⁾ Efficiency class IE1

Technical data, 460 V 60 Hz

IE2 Process performance aluminum motors

IP 55 - IC 411 - Insulation class F, temperature rise class B
IE2 efficiency class according to IEC 60034-30-1: 2014

Output kW	Motor type	Product code	Speed r/min	Efficiency IEC 60034-30-1: 2014			Power factor Cos ϕ	Current		Torque		Moment of inertia J = 1/4 GD ² kgm ²	Weight kg	Sound pressure Level L _{PA} dB	
				Full load 100%	3/4 load 75%	1/2 load 50%		I _N A	I _S /I _N	T _N Nm	T _I /T _N				T _B /T _N
1800 r/min = 4 poles			460 V 60 Hz						High-output design						
0.25 ²⁾	M3AA 63C 4	3GAA062313...F	1697	70.0	66.4	62.7	0.67	0.63	4.6	1.41	2.6	2.7	0.00041	5	55
9.2	M3AA 132MF 4	3GAA132360...E	1765	91.3	91.5	90.2	0.79	16	8.3	49.7	2.3	2.9	0.048	59	63
11	M3AA 132SMF 4	3GAA132260...E	1765	91.5	91.2	89.6	0.80	18.7	8.8	59.5	2.2	3.5	0.0433	83	68
15	M3AA 132SMH 4	3GAA132280...E	1760	91.7	91.5	90.2	0.78	26	8.2	81.54	2.6	3.4	0.0517	82	70
18.5	M3AA 160MLC 4	3GAA162430...G	1774	92.4	92.7	92.0	0.83	30.2	8.7	99.5	3.3	3.6	0.11	127	66
22	M3AA 160MLD 4	3GAA162440...G	1770	92.5	93.2	92.6	0.84	35.4	7.8	118	2.7	3.3	0.125	140	66
30	M3AA 180MLC 4	3GAA182430...G	1777	93.2	93.6	93.0	0.83	48.6	8.3	161	2.9	3.3	0.217	177	66
37	M3AA 200MLB 4	3GAA202420...G	1783	94.2	94.6	94.1	0.84	58.6	8.5	198	2.8	3.3	0.343	234	67
45	M3AA 200MLC 4	3GAA202430...G	1783	94.4	94.5	93.9	0.83	72	8.6	241	3.2	3.6	0.366	246	67
55	M3AA 225SMC 4	3GAA222230...G	1782	94.4	94.6	93.8	0.85	86	8.5	294	3.1	3.4	0.474	287	70
64	M3AA 225SMD 4	3GAA222240...G	1783	94.4	94.4	93.4	0.85	100	9.4	342	3.5	3.7	0.542	314	70
75	M3AA 250SMB 4	3GAA252220...G	1782	94.8	95.0	94.4	0.85	116	8.4	401	3.1	3.5	0.866	350	71
90	M3AA 250SMC 4	3GAA252230...G	1776	95.2	95.3	94.6	0.84	141	8.6	483	3.5	3.7	0.941	377	71

²⁾ Temperature rise class F

Technical data, 460 V 60 Hz

IE2 Process performance aluminum motors

IP 55 - IC 411 - Insulation class F, temperature rise class B
IE2 efficiency class according to IEC 60034-30-1: 2014

Output kW	Motor type	Product code	Speed r/min	Efficiency IEC 60034-30-1: 2014			Power factor Cos ϕ	Current		Torque		Moment of inertia J = 1/4 GD ² kgm ²	Weight kg	Sound pressure Level L _{PA} dB	
				Full load 100%	3/4 load 75%	1/2 load 50%		I _N A	I _S /I _N	T _N Nm	T _I /T _N				T _B /T _N
1200 r/min = 6 poles															
460 V 60 Hz															
CENELEC-design															
0.09	M3AA 63A 6	3GAA063311...F	1110	53.4	48.9	40.6	0.55	0.38	3.2	0.76	2.4	2.8	0.00042	4.2	48
0.12	M3AA 63B 6	3GAA063312...F	1110	50.5	45.5	36.3	0.53	0.51	3.4	1.02	2.6	3.0	0.00052	4.5	53
0.18	M3AA 71A 6	3GAA073311...E	1100	55.0	54.6	48.2	0.64	0.54	3.4	1.56	2.3	2.4	0.0009	5.5	45
0.25	M3AA 71B 6	3GAA073312...E	1120	59.5	57.5	49.9	0.60	0.77	3.8	2.13	2.8	3.0	0.0012	6.5	45
0.37	M3AA 80A 6	3GAA083311...E	1125	73.4	73.5	69.8	0.69	0.91	4.3	3.1	1.8	2.6	0.002	9	47
0.55	M3AA 80C 6	3GAA083313...E	1123	68.0	69.2	66.0	0.71	1.24	5.3	4.67	3.2	3.2	0.0034	15	50
0.75	M3AA 90LB 6	3GAA093520...E	1140	79.6	79.2	75.4	0.67	1.71	4.5	6.2	2.1	2.7	0.0048	18	44
1.1	M3AA 90LD 6	3GAA093540...E	1141	80.3	80.0	77.1	0.64	2.6	5.0	9.1	2.4	3.1	0.0056	20	47
1.5	M3AA 100LC 6	3GAA103530...E	1150	83.3	83.3	81.4	0.70	3.2	4.4	12.4	1.8	2.4	0.009	26	49
2.2	M3AA 112MB 6	3GAA113320...E	1160	84.4	83.8	80.6	0.65	5.0	5.9	18.1	2.5	3.3	0.01	34	56
3	M3AA 132S 6	3GAA133100...E	1161	85.4	84.3	81.0	0.67	6.84	4.7	24.3	1.7	2.8	0.031	46	60
4	M3AA 132MB 6	3GAA133320...E	1177	87.3	86.1	82.9	0.69	8.3	8.0	32.4	2.2	5.1	0.045	54	60
5.5	M3AA 132MC 6	3GAA133330...E	1165	87.6	86.5	83.4	0.67	11.8	6.8	44.96	2.7	3.2	0.049	59	64
7.5	M3AA 160MLA 6	3GAA163410...G	1179	89.6	90.1	88.9	0.77	13.6	7.4	60.7	1.7	3.2	0.087	98	63
11	M3AA 160MLB 6	3GAA163420...G	1177	90.4	91.0	90.0	0.77	19.8	8.4	89.2	2.0	3.4	0.114	125	63
15	M3AA 180MLA 6	3GAA183410...G	1181	91.6	91.9	91.1	0.75	27.4	6.5	121	1.9	3.1	0.168	148	63
18.5	M3AA 200MLA 6	3GAA203410...G	1190	92.2	92.2	91.1	0.79	31.8	7.5	148	2.5	3.2	0.382	196	67
22	M3AA 200MLB 6	3GAA203420...G	1189	92.7	93.1	92.2	0.81	36.7	7.5	176	2.5	3.2	0.448	218	67
30	M3AA 225SMA 6	3GAA223210...G	1189	93.2	93.4	92.4	0.82	49.2	8.0	240	2.8	3.2	0.663	266	67
37	M3AA 250SMA 6	3GAA253210...G	1191	93.6	93.8	93.1	0.81	61.2	7.6	296	2.6	3.0	1.13	294	67

Output kW	Motor type	Product code	Speed r/min	Efficiency IEC 60034-30-1: 2014			Power factor Cos ϕ	Current		Torque		Moment of inertia J = 1/4 GD ² kgm ²	Weight kg	Sound pressure Level L _{PA} dB	
				Full load 100%	3/4 load 75%	1/2 load 50%		I _N A	I _S /I _N	T _N Nm	T _I /T _N				T _B /T _N
1200 r/min = 6 poles															
460 V 60 Hz															
High-output design															
0.18 ²⁾	M3AA 63C 6	3GAA063313...F	1110	68.1	51.6	43.3	0.56	0.66	3.7	1.56	2.6	2.8	0.0006	5.3	45
15	M3AA 160MLC 6	3GAA163430...G	1176	90.7	91.3	90.5	0.75	27.6	8.1	121	1.9	4.1	0.131	138	63
18.5	M3AA 180MLB 6	3GAA183420...G	1180	92.0	92.5	91.8	0.78	32.3	6.6	149	1.9	3.0	0.198	162	63
30	M3AA 200MLC 6	3GAA203430...G	1188	93.0	93.3	92.5	0.83	48.7	8.0	241	2.6	3.2	0.531	245	67
37	M3AA 225SMB 6	3GAA223220...G	1188	93.8	94.1	93.5	0.83	59.6	7.5	297	2.5	3.0	0.821	300	67
45	M3AA 225SMC 6	3GAA223230...G	1187	93.6	94.1	93.6	0.82	73.5	7.3	362	2.5	2.9	0.821	300	67
45	M3AA 250SMB 6	3GAA253220...G	1191	93.9	94.2	93.5	0.82	73.3	7.9	360	2.7	3.1	1.37	341	67
55	M3AA 250SMC 6	3GAA253230...G	1189	94.0	94.3	93.7	0.83	88.4	8.1	441	2.9	3.1	1.5	367	67

²⁾ Temperature rise class F

Variant codes

Aluminum motors

Variant codes specify additional options and features to the standard motor. The desired features are listed as three-digit variant codes in the motor order. Note also that there are variants that cannot be used together.

Most of the variant codes apply to IE2 and IE3 motors. However, confirm the availability of variants for IE3 motors with your ABB sales office before making an order.

Code/Variants	Frame size												
	56	63	71	80	90	100	112	132	160	180	200	225	250
Administration													
531 Sea freight packing.	-	-	•	•	•	•	•	•	•	•	•	•	•
601 Special Sea freight packing	-	-	-	-	-	-	-	-	•	•	•	•	•
Balancing													
052 Vibration acc. to Grade A (IEC 60034-14).	o	o	o	o	o	o	o	o	o	o	o	o	o
426 Half key balancing.	o	o	o	o	o	o	o	o	o	o	o	o	o
Bearings and Lubrication													
037 Roller bearing at D-end.	-	-	-	-	-	-	-	-	•	•	•	•	•
039 Cold-resistant grease.	-	-	o	o	o	o	o	o	o	o	o	o	o
040 Heat-resistant grease.	-	-	o	o	o	o	o	o	o	o	o	o	o
041 Bearings regreasable via grease nipples.	-	-	-	-	•	•	•	•	•	•	•	•	•
042 Locked D-end	o	o	o	o	o	o	o	o	o	o	o	o	o
043 SPM compatible nipples for vibration measurement.	-	-	-	-	-	-	-	-	•	•	•	•	•
057 2RS bearings at both ends.	-	•	•	•	•	•	•	•	•	•	•	•	•
188 63-series bearing in D-end.	-	-	-	-	•	o	o	•	o	o	o	o	o
194 2Z bearings greased for life at both ends	o	o	o	o	o	o	o	o	o	o	o	o	o
195 Bearings greased for life	o	o	o	o	o	o	o	o	o	o	o	o	o
593 Bearings grease suitable for food and beverage industry.	-	-	•	•	•	•	•	•	•	•	•	•	•
781 Lubrication plate put aside	-	-	-	-	-	-	-	-	•	•	•	•	•
795 Lubrication information plate	-	-	-	-	-	-	-	-	•	•	•	•	•
798 Stainless steel grease nipples.	-	-	-	-	-	-	-	-	•	•	•	•	•
Brakes													
086 Reconnection of brake for separate ac supply.	-	-	•	•	•	•	•	•	-	-	-	-	-
088 Brake with mechanical release.	-	-	•	•	•	•	•	•	-	-	-	-	-
288 Brake motor with voltage code S for the motor and separate supply of the brake for voltage corresponding to code D.	-	-	•	•	•	•	•	•	-	-	-	-	-
289 Brake motor with voltage code D for the motor and separate supply of the brake for voltage corresponding to code S.	-	-	•	•	•	•	•	•	-	-	-	-	-
298 Brake motor for 460V with voltage code S and D	-	-	-	-	•	•	•	•	-	-	-	-	-
843 DC Brake. (Sizes 71-132 available as premodified motors with 843)	-	-	o	o	o	o	o	o	•	•	-	-	-
Branch standard designs													
178 Stainless steel / acid proof bolts.	•	•	•	•	•	•	•	•	•	•	•	•	•
210 Special electric design (SEL design)	-	-	-	-	-	-	-	-	-	-	-	•	•
217 Cast iron D-end shield (on aluminum motor).	-	-	-	-	•	•	•	•	o	o	o	o	o
232 Cast iron N-end shield (on aluminium motor)	-	-	-	-	-	-	-	-	o	o	o	o	o
425 Corrosion protected stator and rotor core.	-	-	•	•	•	•	•	•	•	•	•	•	•
Cooling system													
046 Two-directional fan.	o	o	o	o	o	o	o	o	o	o	o	o	o
053 Metal fan cover.	-	-	•	•	•	•	•	•	o	o	o	o	o
068 Light alloy metal fan.	-	-	•	•	•	•	•	•	•	•	•	•	•
183 Separate motor cooling (fan axial, N-end).	-	-	•	•	•	•	•	•	•	•	•	•	•
205 Non metallic fan.	o	o	o	o	o	o	o	o	o	o	o	o	o
792 Metal fasteners for fan cover.	o	o	o	o	o	o	o	o	o	o	o	o	o
Documentation													
141 Binding 2D main dimension drawing.	•	•	•	•	•	•	•	•	•	•	•	•	•
Drain holes													
065 Plugged existing drain holes.	-	-	-	-	-	-	-	-	•	•	•	•	•
Earthing Bolt													
067 External earthing bolt.	-	•	•	•	•	•	•	•	•	•	•	•	•

o = Included as standard | • = Available as option | - = Not applicable

Code/Variants		Frame size												
		56	63	71	80	90	100	112	132	160	180	200	225	250
Hazardous Environments														
335	Ex t, Dust group III B T125C Dc, IP5X (non-conductive dust) acc. IEC/EN60079-31.	-	-	-	-	-	-	-	-	●	●	●	●	●
336	Ex t, Dust group III C T125 Db, IP6X (conductive dust) acc. IEC/EN60079-31.	-	-	-	-	-	-	-	-	●	●	●	●	●
338	Rated for gas or dust, Ex ec IIC T3 Gc / Ex tc IIIB T125C Dc (non-conductive dust), IP5X.	-	-	-	-	○	○	○	○	-	-	-	-	-
339	Rated for gas or dust, Ex ec IIC T3 Gc / Ex tc IIIC T125C Dc (conductive dust), IP6X.	-	-	-	-	○	○	○	○	-	-	-	-	-
456	Ex ec IIC T3 Gc acc. IEC/EN 60079-7 with certificates.	-	-	-	-	○	○	○	○	●	●	●	●	●
Heating elements														
450	Heating element, 100-120 V.	-	-	●	●	●	●	●	●	●	●	●	●	●
451	Heating element, 200 - 240 V.	-	-	●	●	●	●	●	●	●	●	●	●	●
Marine														
096	Fulfilling Lloyds Register of Shipping (LR) requirements, without certificate (non-essential duty only).	-	-	●	●	●	●	●	●	●	●	●	●	●
186	Fulfilling Det Norske Veritas (DNV) requirements, without certificate.	-	-	●	●	●	●	●	●	●	●	●	●	●
492	Fulfilling Registro Italiano Navale (RINA) requirements, without certificate.	-	-	●	●	●	●	●	●	●	●	●	●	●
493	Fulfilling China Classification Societies (CCS) requirements (Beijing), without certificate.	-	-	●	●	●	●	●	●	●	●	●	●	●
496	Fulfilling Bureau Veritas (BV) requirements, without certificate(non-essential duty only).	-	●	●	●	●	●	●	●	●	●	●	●	●
675	Fulfilling American Bureau of Shipping (ABS) requirements, without certificate (non-essential duty only).	-	-	●	●	●	●	●	●	●	●	●	●	●
Mounting arrangements														
007	IM 3001 flange mounted, IEC flange, from IM 1001 (B5 from B3).	-	-	-	-	-	-	-	-	●	●	●	●	●
008	IM 2101 foot/flange mounted, IEC flange, from IM 1001 (B34 from B3).	●	●	●	●	●	●	●	●	●	●	-	-	-
009	IM 2001 foot/flange mounted, IEC flange, from IM 1001 (B35 from B3).	●	●	●	●	●	●	●	●	●	●	●	●	●
047	IM 3601 flange mounted, IEC flange, from IM 3001 (B14 from B5).	●	●	●	●	●	●	●	●	●	●	-	-	-
048	IM 3001 flange mounted, IEC flange, from IM 3601 (B5 from B14).	-	-	●	●	●	●	●	●	-	-	-	-	-
066	Modified for specified mounting position differing from IM B3 (1001), IM B5 (3001), B14 (3601), IM B35 (2001), IM B34 (2101).	●	●	●	●	●	●	●	●	●	●	●	●	●
200	Flange ring holder.	-	-	●	●	●	●	●	●	-	-	-	-	-
223	Flange ring FF 115.	-	-	●	●	●	-	-	-	-	-	-	-	-
224	Flange ring FT 115.	-	-	●	●	●	-	-	-	-	-	-	-	-
226	Flange ring FF 130.	-	-	●	●	●	●	●	-	-	-	-	-	-
227	Flange ring FT 130.	-	-	●	●	●	●	●	-	-	-	-	-	-
233	Flange ring FF 165.	-	-	-	●	●	●	●	●	-	-	-	-	-
234	Flange ring FT 165.	-	-	-	●	●	●	●	●	-	-	-	-	-
243	Flange ring FF 215.	-	-	-	-	-	-	●	●	-	-	-	-	-
253	Flange ring FF 265.	-	-	-	-	-	-	-	●	-	-	-	-	-
255	Flange FF 265.	-	-	-	-	-	-	-	●	-	-	-	-	-
260	Flange FT 115.	-	-	-	-	●	-	-	-	-	-	-	-	-
Painting														
114	Special paint color, standard grade.	●	●	●	●	●	●	●	●	●	●	●	●	●
714	Customer painting specification	-	-	-	-	-	-	-	-	●	●	●	●	●
Protection														
005	Protective roof.	●	●	●	●	●	●	●	●	●	●	●	●	●
072	Radial seal at D-end. Not possible for 2-pole , 280 and 315 frames.	-	-	●	●	●	●	●	●	●	●	●	●	●
074	Degree of protection IP55.	○	○	○	○	○	○	○	○	○	○	○	○	○
158	Degree of protection IP65.	-	-	●	●	●	●	●	●	●	●	●	●	●
250	Degree of protection IP66.	-	-	●	●	●	●	●	●	●	●	●	●	●
403	Degree of protection IP56.	-	-	●	●	●	●	●	●	●	●	●	●	●
784	Gamma-seal at D-end.	-	-	-	-	●	●	●	●	●	●	●	●	●

○ = Included as standard | ● = Available as option | - = Not applicable

Code/Variants	Frame size												
	56	63	71	80	90	100	112	132	160	180	200	225	250
Rating & instruction plates													
002	Restamping voltage, frequency and output, continuous duty.	●	●	●	●	●	●	●	●	●	●	●	●
003	Individual serial number.	○	○	○	○	○	○	○	○	○	○	○	○
004	Additional text on std rating plate (max 12 digits on free text line).	-	-	●	●	●	●	●	●	●	●	●	●
095	Restamping output (maintained voltage, frequency), intermittent duty.	●	●	●	●	●	●	●	●	●	●	●	●
098	Stainless steel rating plate.	-	-	●	●	●	●	●	●	●	●	●	●
126	Tag plate.	●	●	●	●	●	●	●	●	●	●	●	●
135	Mounting of additional identification plate, stainless steel.	-	-	●	●	●	●	●	●	●	●	●	●
138	Mounting of additional identification plate, aluminium.	-	●	●	●	●	●	●	●	●	●	●	●
159	Additional plate with text "Made in".	●	●	●	●	●	●	●	●	●	●	●	●
160	Additional rating plate affixed.	-	-	-	-	●	●	●	●	●	●	●	●
161	Additional rating plate delivered loose.	●	●	●	●	●	●	●	●	●	●	●	●
162	Rating plate fixed to stator	○	○	○	○	○	○	○	○	○	○	○	○
163	Frequency converter rating plate. Rating data according to quotation.	-	-	-	●	●	●	●	●	●	●	●	●
181	Rating plate with ABB standard loadability values for VSD operation. Other auxiliaries for VSD operation to be selected as necessary.	-	-	●	●	●	●	●	●	●	●	●	●
332	Baldor Catalogue #.	●	●	●	●	●	●	●	●	●	●	●	●
Shaft & rotor													
164	Shaft extension with closed keyway	○	○	○	○	○	○	○	○	○	○	○	○
Standards and Regulations													
208*	Fulfilling Underwriters Laboratories (UL), listed requirements.	-	-	-	○	○	○	○	○	●	●	●	●
331	Motor not for sale for use in EU.	-	-	●	●	●	●	●	●	●	●	●	●
509*	Fulfilling US Integral Horsepower Motor Rule (IHP).	-	-	-	○	○	○	○	○	●	●	●	●
538	CE mark	-	-	○	○	○	○	○	○	○	○	○	○
540*	China energy label.	-	-	-	●	●	●	●	●	●	●	●	●
543	Australian MEPS.	-	-	-	●	●	●	●	●	●	●	●	●
544	Australian HE MEPS	-	-	-	●	●	●	●	●	●	●	●	●
586	UKCA mark	-	-	○	○	○	○	○	○	○	○	○	○
598	Universal motor	-	-	-	-	-	-	-	●	●	●	●	●
687	Fulfilling energy efficiency requirements for Canada	-	-	-	-	-	-	-	●	●	●	●	●
Stator winding temperature sensors													
122	Bimetal detectors, break type (NCC), (3 in series), 150 °C, in stator winding.	-	-	●	●	●	●	●	●	●	●	●	●
436	PTC - thermistors (3 in series), 150 °C, in stator winding.	●	●	●	●	●	○	○	○	○	○	○	○
445	Pt100 2-wire in stator winding, 1 per phase.	-	-	-	-	-	-	-	●	●	●	●	●
Terminal box													
015	Motor supplied in D connection.	-	-	●	●	●	●	●	●	●	●	●	●
017	Motor supplied in Y connection.	-	-	-	-	●	●	●	●	●	●	●	●
018	Small terminal box	-	-	-	-	-	-	-	●	●	●	●	●
019	Larger than standard terminal box.	-	-	-	-	-	-	-	-	-	●	●	●
021	Terminal box LHS (seen from D-end).	-	-	-	-	-	-	-	-	-	●	●	●
022	Cable entry LHS (seen from D-end).	-	-	-	-	-	-	-	-	-	●	●	●
180	Terminal box RHS (seen from D-end).	-	-	-	-	-	-	-	-	-	●	●	●
230	Standard metal cable gland.	-	-	●	●	●	●	●	●	●	●	●	●
375	Standard plastic cable gland.	-	-	●	●	●	●	●	●	-	-	-	-
465	Terminal box on top.	○	○	○	○	○	○	○	○	○	○	○	○
731	Two standard metal cable glands.	-	-	-	-	-	-	-	-	●	●	●	●
738	Prepared for metric cable glands.	○	○	○	○	○	○	○	○	○	○	○	○
Testing													
145	Type test report from a catalogue motor, 400V 50Hz.	●	●	●	●	●	●	●	●	●	●	●	●
148	Routine test report.	●	●	●	●	●	●	●	●	●	●	●	●
Variable speed drives													
701	Insulated bearing at N-end.	-	-	-	-	-	-	-	-	●	●	●	●
704	EMC cable entry.	-	-	-	-	●	●	●	●	●	●	●	●
Y/D starting													
023	6 terminals (for Y/D start, single speed), in terminal box.	○	○	○	○	○	○	○	○	○	○	○	○

○ = Included as standard | ● = Available as option | - = Not applicable

* Valid only for registered motors (Motor type M3AA with generation K)

Mechanical design

Motor frame and drain holes

Motor frame

The motor frame is made of aluminum alloy. Frame sizes 56 to 180 have aluminum feet and sizes 200 to 250 have cast iron feet.

The bearing end shields of sizes 56 to 132 are made of aluminum, and those of 160 to 250 are made of cast iron.

Drain holes

Motors that will be operated in very humid or wet environments and especially under intermittent duty should be provided with drain holes. The IM designation, such as IM 3031, determines the intended mounting arrangement for the motor.

Motors are provided with closable plastic plugs in the drain holes. The plugs on delivery, when mounting the motors, ensure that the drainholes face downwards. In the case of vertical mounting, the upper plug must be hammered home completely. In very dusty environments both plugs should be hammered home.

Motors are supplied with drain holes both at the D-end and N-end.

When mounting arrangement differs from foot mounted IM B3, please use variant code 066 when ordering.

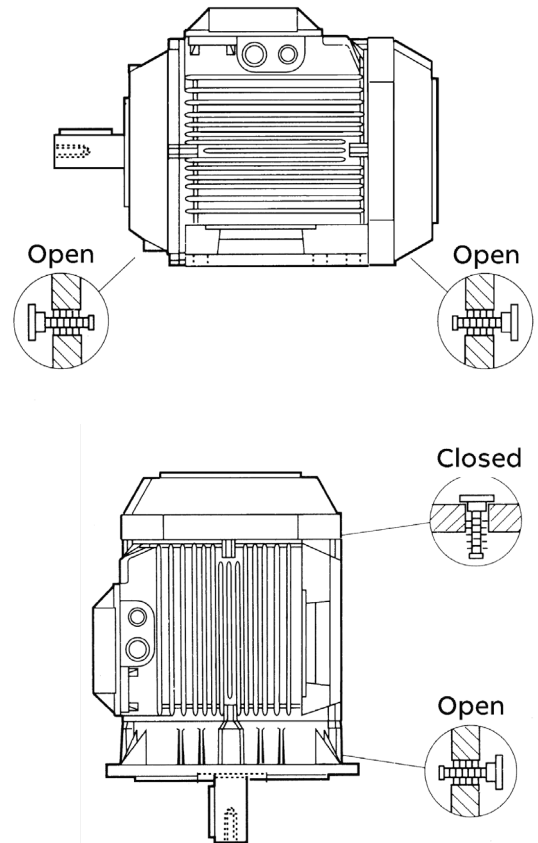

Mechanical design

Bearings

The motors are provided with bearings according to the tables below. Greater axial forces can be tolerated if the motors are provided with angular contact ball bearings.

Standard design: deep groove ball bearings

Motor size	Number of poles	Standard design	
		Deep groove ball bearings	
		D-end	N-end
56	-	6201-2Z/C3	6201-2Z/C3
63	-	6201-2Z/C3	6201-2Z/C3
71	-	6203-2Z/C3	6202-2Z/C3
80	-	6204-2Z/C3	6203-2Z/C3
90	-	6205-2Z/C3	6204-2Z/C3
100	-	6306-2Z/C3	6205-2Z/C3
112	-	6306-2Z/C3	6205-2Z/C3
132 ¹⁾	-	6208-2Z/C3	6206-2Z/C3
132 ²⁾	-	6208-2Z/C3	6206-2Z/C3
132 ³⁾	-	E2.6208-2Z/C3	E2.6206-2Z/C3
132 ⁴⁾	-	E2.6308-2Z/C3	E2.6206-2Z/C3
160	-	6309-2Z/C3	6209-2Z/C3
180	-	6310-2Z/C3	6209-2Z/C3
200	-	6312-2Z/C3	6210-2Z/C3
225	-	6313-2Z/C3	6212-2Z/C3
250	-	6315-2Z/C3	6213-2Z/C3

¹⁾ all types except ³⁾ 2p 9,2kW (HO)
²⁾ SM_ ⁴⁾ 2p 15kW (HO)

Note that in such cases the axial force must only operate in one direction. Motor versions with roller bearings tolerate greater radial forces.

Alternative design with roller bearings

It is recommended to use roller bearings in belt drives for motor sizes 160 to 250.

See variant code 037 under the heading "Bearings and lubrication".

Motor size	Number of poles	Alternative designs	
		Roller bearings (037)	
		D-end	N-end
56	-	-	-
63	-	-	6201-2Z/C3
71	-	-	6202-2Z/C3
80	-	-	6203-2Z/C3
90	-	NU 205	6204-2Z/C3
100	-	NU 306	6205-2Z/C3
112	-	NU 306	6205-2Z/C3
132 ¹⁾	-	NU 208	6206-2Z/C3
132 ²⁾	-	NU 308	6206-2Z/C3

¹⁾ all types except ³⁾ 2p 9,2kW (HO)
²⁾ SM_ ⁴⁾ 2p 15kW (HO)

Motor size	Number of poles	Alternative designs	
		Roller bearings (037)	
		D-end	N-end
132 ³⁾	-	-	-
132 ⁴⁾	-	-	-
160	-	NU 309 ECP	6209-2Z/C3
180	-	NU 310 ECP	6209-2Z/C3
200	-	NU 312 ECP	6210-2Z/C3
225	-	NU 313 ECP	6212-2Z/C3
250	-	NU 315 ECP	6213-2Z/C3

¹⁾ all types except ³⁾ 2p 9,2kW (HO)
²⁾ SM_ ⁴⁾ 2p 15kW (HO)

Alternative design: angular contact ball bearings

See variant codes 058 and 059 under the heading "Bearings and lubrication".

Motor size	Number of poles	Ang. contact ball bearings (058, 059)	
		D-end	N-end
		56-80	-
90	-	7205 B	7204 B
100	-	7306 B	7205 B
112	-	7306 B	7205 B
132 ¹⁾	-	7208 B	7206 B
132 ²⁾	-	7308 B	7206 B
132 ³⁾	-	-	-
132 ⁴⁾	-	-	-
160	-	7309 BEP	7209 BEP
180	-	7310 BEP	7209 BEP
200	-	7312 BEP	7210 BEP
225	-	7313 BEP	7212 BEP
250	-	7315 BEP	7213 BEP

¹⁾ all types except ³⁾ 2p 9,2kW (HO)
²⁾ SM_ ⁴⁾ 2p 15kW (HO)

01 Motor sizes 71 - 132.

02 Motor sizes 160 - 250.

Transport locking

Motors provided with roller bearings or angular contact ball bearings are fitted with a transport lock to prevent damage to the bearings, due to vibration, during transport.

Axially locked bearings

The table below shows which of the motor's bearings are axially locked in the bearing seat. In motor size 63 the locking is done by an internal retaining ring, in motor sizes 71 to 250 by an inner bearing cover.

Motor size	Foot-mounted motors	Flange-mounted motors	
		Large flange	Small flange
56	N/A	N/A	N/A
63	N/A	N/A	N/A
71-132	D-end ¹⁾	D-end ¹⁾	D-end ¹⁾
160-250	D-end	D-end	-

¹⁾A spring-washer at the N-end presses the rotor toward the D-end.

Bearing seals

Motor size	Number of poles	Standard design, axial seal		Alternative design Radial seal (Din3760) Variant code 073
		D-end	N-end	
56	2-4	V-ring	Labyrinth seal	
63	2-8	V-ring	Labyrinth seal	
71	2-12	V-16A	Labyrinth seal	17x28x7
80	2-12	V-20A	Labyrinth seal	20x40x7
90	2-12	V-25A	Labyrinth seal	25x42x7
100	2-12	V-30A	Labyrinth seal	30x47x7
112	2-12	V-30A	Labyrinth seal	30x47x7
132	2-12	V-40A	Labyrinth seal	40x62x7
160	2-12	V-45A	V-45A	45x65x8
180	2-12	V-50A	V-45A	50x72x8
200	2-12	V-60A	V-50A	60x80x8
225	2-12	V-65A	V-60A	65x85x8
250	2-12	V-75A	V-65A	75x95x8

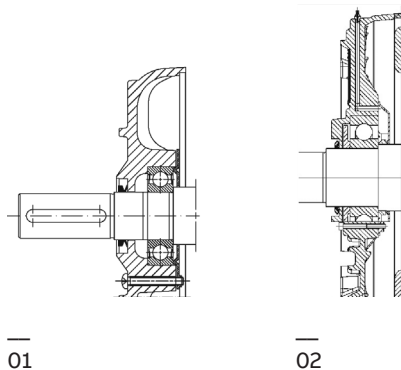

01

02

Bearing life and lubrication

Bearing life

The nominal life is defined as the number of hours that are attained or exceeded by 90 percent of identical bearings, in a large test series, under certain specified conditions. 50 percent of the bearings attain a life of as much as 5 times this figure.

The life of bearings is dependent on various factors such as bearing load, motor speed, operating temperature and the purity of the grease. The permissible radial and axial loading for different motor sizes is shown in the table on the following pages.

The table is valid for 50 Hz. For 60 Hz and/or some other bearing life than specified in the table the values are changed according to the table below.

The table values assume the occurrence of only radial or axial forces. In the case of simultaneous radial and axial forces information can be supplied on request. It is assumed that the radial force is applied at the end of the motor shaft.

Permissible force at changed bearing life or supply frequency

Bearing life in hours at		
50 Hz	60 Hz	
25 000	21 000	100 % of value for 25.000 hours
40 000	33 000	100 % of value for 40.000 hours
63 000	52 000	86 % of value for 40.000 hours
80 000	67 000	80 % of value for 40.000 hours

Lubrication

The motors are delivered with bearing grease for use at normal temperatures in dry or humid environments. The motors are lubricated for ambient temperatures 40 °C and in other temperatures above 40 °C, see table next page.

Motor sizes 56 to 250 are provided with shielded bearings. As an option, motor sizes 90 to 250 are provided with grease nipples for regreasing, see variant code 041 under the heading "Bearings and lubrications".

Lubrication intervals and grease quantities are specified on a plate on the motor as well as in the manual supplied with the motor.

The grease lifetime L_{10} , suitable for permanent lubricated bearings, is defined as the number of operating hours after which 90 percent of the bearings are adequately lubricated. 50 percent of the bearings achieve two times this figure. Maximum lifetime, however, should be regarded as 40,000 hours.

In case of high ambient temperatures the shaft loads must be reduced compared to permissible loadings in the table, please contact ABB.

Grease lifetime in vertically mounted motors

In vertically mounted motors, the grease lifetime is half the figures as in following table. For applications corresponding to the empty cells in the table, please contact ABB. These applications can imply reduced lifetime for bearings and winding. Motors with roller bearings (optional) have considerably shorter grease life. For continuous operation regreasing nipples should be considered.

Grease lifetime

Ambient temperature and rated output													
Motor	r/min	25 °C		40 °C		50 °C		60 °C		70 °C		80 °C	
		Basic	High	Basic	High	Basic	High	Basic	High	Basic	High	Basic	High
56	3000	40 000	40 000	40 000	40 000	40 000	40 000	31 000	31 000	17 000	17 000	9 000	9 000
	1500	40 000	40 000	40 000	40 000	40 000	40 000	33 000	33 000	18 000	18 000	9 000	9 000
	1000	40 000	40 000	40 000	40 000	40 000	40 000	33 000	33 000	18 000	18 000	9 000	9 000
	750	40 000	40 000	40 000	40 000	40 000	40 000	33 000	33 000	18 000	18 000	9 000	9 000
63	3000	40 000	40 000	40 000	40 000	40 000	40 000	31 000	31 000	17 000	17 000	9 000	9 000
	1500	40 000	40 000	40 000	40 000	40 000	40 000	33 000	33 000	18 000	18 000	9 000	9 000
	1000	40 000	40 000	40 000	40 000	40 000	40 000	33 000	33 000	18 000	18 000	9 000	9 000
	750	40 000	40 000	40 000	40 000	40 000	40 000	33 000	33 000	18 000	18 000	9 000	9 000
71	3000	40 000	40 000	40 000	40 000	40 000	40 000	27 000	27 000	15 000	15 000	8 000	8 000
	1500	40 000	40 000	40 000	40 000	40 000	40 000	33 000	33 000	18 000	18 000	9 000	9 000
	1000	40 000	40 000	40 000	40 000	40 000	40 000	33 000	33 000	18 000	18 000	9 000	9 000
	750	40 000	40 000	40 000	40 000	40 000	40 000	33 000	33 000	18 000	18 000	9 000	9 000
80	3000	40 000	40 000	40 000	40 000	39 000	39 000	23 000	23 000	13 000	13 000	7 000	7 000
	1500	40 000	40 000	40 000	40 000	40 000	40 000	33 000	33 000	18 000	18 000	9 000	9 000
	1000	40 000	40 000	40 000	40 000	40 000	40 000	33 000	33 000	18 000	18 000	9 000	9 000
	750	40 000	40 000	40 000	40 000	40 000	40 000	33 000	33 000	18 000	18 000	9 000	9 000
90	3000	40 000	40 000	40 000	40 000	33 000	33 000	20 000	20 000	11 000	11 000	6 000	6 000
	1500	40 000	40 000	40 000	40 000	40 000	40 000	33 000	33 000	18 000	18 000	9 000	9 000
	1000	40 000	40 000	40 000	40 000	40 000	40 000	33 000	33 000	18 000	18 000	9 000	9 000
	750	40 000	40 000	40 000	40 000	40 000	40 000	33 000	33 000	18 000	18 000	9 000	9 000
100	3000	40 000	40 000	39 000	39 000	25 000	25 000	15 000	15 000	8 000	8 000	4 000	4 000
	1500	40 000	40 000	40 000	40 000	40 000	40 000	30 000	30 000	17 000	17 000	9 000	9 000
	1000	40 000	40 000	40 000	40 000	40 000	40 000	33 000	33 000	18 000	18 000	9 000	9 000
	750	40 000	40 000	40 000	40 000	40 000	40 000	33 000	33 000	18 000	18 000	9 000	9 000
112 1)	3000	40 000	40 000	39 000	39 000	25 000	25 000	15 000	15 000	8 000	8 000	4 000	4 000
	1500	40 000	40 000	40 000	40 000	40 000	40 000	30 000	30 000	17 000	17 000	9 000	9 000
	1000	40 000	40 000	40 000	40 000	40 000	40 000	33 000	33 000	18 000	18 000	9 000	9 000
	750	40 000	40 000	40 000	40 000	40 000	40 000	33 000	33 000	18 000	18 000	9 000	9 000
132 1)	3000	40 000	40 000	33 000	33 000	21 000	21 000	13 000	13 000	7 000	7 000	4 000	4 000
	1500	40 000	40 000	40 000	40 000	40 000	40 000	26 000	26 000	14 000	14 000	7 000	7 000
	1000	40 000	40 000	40 000	40 000	40 000	40 000	33 000	33 000	18 000	18 000	9 000	9 000
	750	40 000	40 000	40 000	40 000	40 000	40 000	33 000	33 000	18 000	18 000	9 000	9 000
132 2)	3000	40 000	40 000	31 000	31 000	20 000	20 000	12 000	12 000	6 000	6 000	3 000	3 000
	1500	40 000	40 000	40 000	40 000	40 000	40 000	24 000	24 000	13 000	13 000	7 000	7 000
	1000	40 000	40 000	40 000	40 000	40 000	40 000	33 000	33 000	18 000	18 000	9 000	9 000
	750	40 000	40 000	40 000	40 000	40 000	40 000	33 000	33 000	18 000	18 000	9 000	9 000
160	3000	40 000	40 000	40 000	36 000	40 000	19 000	26 000	9 000	14 000	5 000	8 000	2 000
	1500	40 000	40 000	40 000	40 000	40 000	40 000	40 000	38 000	40 000	20 000	37 000	10 000
	1000	40 000	40 000	40 000	40 000	40 000	40 000	40 000	40 000	40 000	24 000	40 000	12 000
	750	40 000		40 000		40 000		40 000		40 000		40 000	
180	3000	38 000	38 000	38 000	38 000	38 000	38 000	38 000	23 000	23 000	12 000	13 000	7 000
	1500	40 000	40 000	40 000	40 000	40 000	24 000	40 000	12 000	26 000	6 000	13 000	3 000
	1000	40 000	40 000	40 000	40 000	40 000	40 000	40 000	40 000	40 000	24 000	29 000	12 000
	750	40 000		40 000		40 000		40 000		37 000		21 000	
200	3000	27 000	27 000	27 000	27 000	27 000	18 000	24 000	10 000	14 000	5 000	8 000	3 000
	1500	40 000	40 000	40 000	40 000	40 000	40 000	40 000	32 000	40 000	18 000	30 000	10 000
	1000	40 000	40 000	40 000	40 000	40 000	40 000	40 000	40 000	40 000	30 000	38 000	17 000
	750	40 000		40 000		40 000		40 000		40 000		40 000	
225	3000	23 000	23 000	23 000	18 000	23 000	10 000	20 000	6 000	12 000	3 000	7 000	1 000
	1500	40 000	40 000	40 000	40 000	40 000	23 000	40 000	12 000	40 000	6 000	25 000	3 000
	1000	40 000	40 000	40 000	40 000	40 000	40 000	40 000	40 000	40 000	40 000	40 000	27 000
	750	40 000		40 000		40 000		40 000		40 000		40 000	
250	3000	16 000	16 000	16 000	13 000	16 000	7 000	12 000	4 000	7 000	2 000	4 000	1 000
	1500	40 000	40 000	40 000	39 000	40 000	21 000	40 000	11 000	33 000	6 000	19 000	3 000
	1000	40 000	40 000	40 000	40 000	40 000	40 000	40 000	40 000	40 000	25 000	36 000	13 000
	750	40 000		40 000		40 000		40 000		40 000		40 000	

¹⁾ all types except

²⁾ SM_

Mechanical design

Radial forces

Permissible loading on shaft

The tables give the permissible radial force in Newtons, assuming zero axial force, ambient temperature of 25°C.

Permissible loads of simultaneous radial and axial forces will be supplied on request.

The bearing life, L_{10} , is calculated according to SKF's theory on bearing life $L_{10\text{aah}}$, which also takes the purity of the grease into consideration. An adequate lubrication is a necessary prerequisite for the table at right.

If the radial force is applied between points X_0 and X_{max} , the permissible force F_R can be calculated from the following formula:

$$F_R = F_{X0} - \frac{X}{E} (F_{X0} - F_{X\text{max}})$$

Where:

E: length of the shaft extension in the standard version

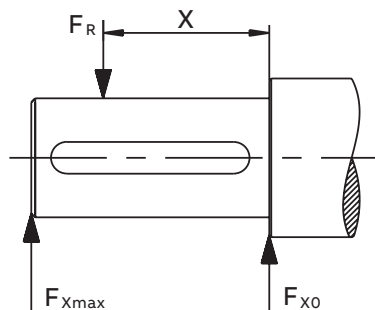

Permissible radial forces

Motor size	Poles	Length of shaft extension E (mm)	Basic design with deep groove ball bearings				Roller bearings			
			Mounting arrangement IM B3				Mounting arrangement IM B3			
			20,000 h		40,000 h		20,000 h		40,000 h	
			F_{x0} (N)	F_{xmax} (N)	F_{x0} (N)	F_{xmax} (N)	F_{x0} (N)	F_{xmax} (N)	F_{x0} (N)	F_{xmax} (N)
56	2	20	348	299	376	237				
	4	20	438	376	347	298				
63	2	23	355	306	281	242				
	4	23	447	385	354	305				
	6	23	512	441	405	349				
71	2-6	30	680	570	680	570				
80	2	40	630	750	930	750				
80	4-6	40	930	750	930	750				
90	2-6	50	1010	810	1010	810				
100	2-6	60	2280	1800	2280	1800				
112	2-6	60	2280	1800	2280	1800				
132 ¹⁾	2-6	80	2120	1610	2120	1610				
132 ²⁾	2-6	80	2600	2100	2600	2100				

¹⁾ 62-series bearings

²⁾ 63-series bearings

Motor size	Poles	Length of shaft extension E (mm)	Basic design with deep groove ball bearings				Roller bearings			
			Mounting arrangement IM B3				Mounting arrangement IM B3			
			20,000 h		40,000 h		20,000 h		40,000 h	
			F_{x0} (N)	F_{xmax} (N)	F_{x0} (N)	F_{xmax} (N)	F_{x0} (N)	F_{xmax} (N)	F_{x0} (N)	F_{xmax} (N)
160	2	110	4 760	3860	4100	3320	6580	4300	5620	4300
	4	110	5 180	4200	4380	3545	7340	4300	6180	4300
	6	110	5160	4180	4360	3540	7780	4300	6500	4300
180	2	110	6 060	4960	5280 ¹⁾	4305 ¹⁾	7600	5500	6560	5500
	4	110	4 800	3940	4020	3300	7280	5500	6140	5500
	6	110	6280	5140	5280	4380	8680	5500	7280	5500
200	2	110	7800	6500	6760 ²⁾	5640 ²⁾	10 360	8640	8880	7400
	4	110	8400	7020	7180	5980	11 560	9550	9800	8180
	6	110	8960	7480	7600	6340	12 480	9550	10 520	8780
225	2	110	8520	7180	7360 ³⁾	6200 ³⁾	12 320	10 380	10 560	8900
	4	140	8380	6780	7200	5820	13 380	10 250	11 320	9160
	6	140	10 960	8860	9360	7560	15 860	10 250	13 420	10 250
250	2	140	10 480 ⁴⁾	8500 ⁴⁾	9080 ⁴⁾	7360 ⁴⁾	16 220	10 900	13 960	10 900
	4	140	10 840	8780	9380	7600	18 020	13 800	15 320	13 800
	6	140	12 600	10 220	10 700	8680	20 240	13 800	17 140	13 800

¹⁾ The maximum lifetime of the grease is 38000 h

²⁾ The maximum lifetime of the grease is 27000 h

³⁾ The maximum lifetime of the grease is 23000 h

⁴⁾ The maximum lifetime of the grease is 16000 h

Mechanical design

Axial forces

01 Mounting arrangement IM B3.

02 Mounting arrangement IM V1.

The following tables present permissible axial forces on the shaft in Newtons, assuming zero radial force, a 25 °C ambient temperature, and normal conditions. The values are given for a calculated bearing life of 20,000 and 40,000 hours per motor size.

At 60 Hz, the values must be reduced by 10 percent. Permissible loads of simultaneous radial and axial forces can be supplied on request.

For axial force F_{AD} , it is assumed that the D-bearing is locked with a locking ring.

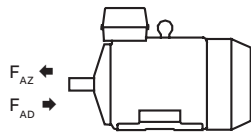

01

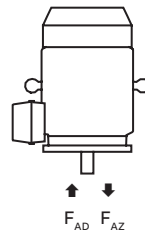

02

Permissible axial forces

Motor size	Poles	Mounting arrangement IM B3, deep groove ball bearings				Mounting arrangement IM V1, deep groove ball bearings			
		20,000 h		40,000 h		20,000 h		40,000 h	
		F_{AD} (N)	F_{AZ} (N)	F_{AD} (N)	F_{AZ} (N)	F_{AD} (N)	F_{AZ} (N)	F_{AD} (N)	F_{AZ} (N)
56	2	261	261	193	193	269	256	201	187
	4	355	355	260	260	366	378	272	253
63	2	260	260	192	192	272	253	204	185
	4	353	353	259	259	371	343	277	248
	6	423	423	310	310	443	412	330	298
71	2	625	325	515	215	640	315	530	200
	4	780	480	630	330	800	470	650	320
	6	890	590	710	410	925	570	745	390
80	2	810	470	650	315	845	450	690	290
	4	1015	675	810	470	1075	640	865	430
	6	1170	830	925	595	1225	795	980	550
90	2	885	485	720	320	945	450	775	280
	4	1170	650	945	425	1245	600	1020	375
	6	1270	870	1005	605	1360	815	1095	550

Permissible axial forces

Motor size	Poles	Mounting arrangement IM B3, deep groove ball bearings				Mounting arrangement IM V1, deep groove ball bearings			
		20,000 h		40,000 h		20,000 h		40,000 h	
		F _{AD} (N)	F _{AZ} (N)	F _{AD} (N)	F _{AZ} (N)	F _{AD} (N)	F _{AZ} (N)	F _{AD} (N)	F _{AZ} (N)
100	2	1620	1120	1280	780	1710	1060	1370	715
	4	2065	1565	1615	1115	2180	1485	1735	1035
	6	2390	1890	1860	1360	2510	1815	1980	1285
112 M, MB	2	1615	1115	1275	775	1725	1040	1385	700
	4	2060	1560	1610	1110	2210	1460	1110	1010
	6	2385	1885	1860	1360	2540	1785	2010	1260
132 M, MA	4	2245	1645	1760	1160	2460	1505	1970	1015
	6	2595	1980	2025	1425	2815	1850	2245	1280
132 MC	6	2580	1980	2010	1410	2885	1780	2315	1210
132 MBA	4	2235	1635	1750	1150	2495	1465	2010	980
132 S	6	2600	2000	2030	1435	2780	1885	2210	1315
132 SB	2	1760	1160	1400	800	1910	1075	1540	705
132 SBB, SC	2	1760	1160	1395	795	1945	1045	1575	670
132 SMB, SMC	2	2210	1610	1740	1140	2435	1470	1950	985
	4	2840	2240	2205	1605	3150	2035	2515	1400
132 SMD	4	2830	2200	2230	1595	3195	1995	2560	1355
132 SME	2	2210	1610	1730	1130	2490	1425	2005	940
160	2	4160	4160	3425	3425	4560	3810	3860	3110
	4	4740	4740	3920	3920	5260	4310	4440	3490
	6	4840	4840	4000	4000	5400	4420	4540	3560
180	2	5480	5480	4600 ¹⁾	4600 ¹⁾	5920	5115	5060 ¹⁾	4255 ¹⁾
	4	4360	4360	3540	3540	5080	3860	4240	3020
	6	5980	5980	4940	4630	6000	5445	5600	4385
200	2	5000	6880	5000 ²⁾	5700 ²⁾	5000	6350	5000 ²⁾	5230 ²⁾
	4	5000	7660	5000	6340	5000	6950	5000	5650
	6	5000	8300	5000	6880	5000	7505	5000	6025
225	2	5000	7380	5000 ³⁾	6120 ³⁾	5000	6770	5000 ³⁾	5490 ³⁾
	4	5000	7600	5000	6220	5000	6795	5000	5475
	6	5000	10140	5000	8420	5000	9270	5000	7490
250	2	6000 ⁴⁾	9020 ⁴⁾	6000 ⁴⁾	7500 ⁴⁾	6000 ⁴⁾	8335 ⁴⁾	6000 ⁴⁾	6755 ⁴⁾
	4	6000	9800	6000	8040	6000	8820	6000	7120
	6	6000	11520	6000	9520	6000	10 275	6000	8235

¹⁾ The maximum lifetime of the grease is 38 000 h

²⁾ The maximum lifetime of the grease is 27 000 h

³⁾ The maximum lifetime of the grease is 23 000 h

⁴⁾ The maximum lifetime of the grease is 16 000 h

Mechanical design

Terminal box

Sizes 56 to 180

The terminal box is made of aluminum alloy and is located on top of the stator. The lower part of the box is integrated with the stator. It is provided with two knockout openings on each side. Sizes 132 SM_ and 160 - 180 also have a third smaller opening. Cable glands are not included.

Sizes 200 to 250

The terminal box and cover are made of deep drawn steel and mounted on top of the stator. The box is bolted to the stator and is not rotatable. The size of the box is the same for all frame sizes.

The motors can also be provided with an extra large terminal box. See variant code 019 under the heading "Terminal box". This will increase the dimension HD by 32 mm. The box is supplied with two FL 21 openings. The right opening is provided with a flange with two holes for M63 cable glands. The holes are sealed by means of plastic plugs. Cable glands are not supplied. The opening on the other side is provided with a cover flange. The box can also be provided with an FL 13 opening towards the N-end.

When new motors are manufactured the terminal box can be mounted on the left or the right side. See variant codes 021 and 180 under the heading "Terminal box".

In the basic design the terminal box is provided with two FL 13 flange openings, one on each side. The opening on the right side, seen from the D-end, is supplied with a flange with two holes for M40 cable glands. On delivery the holes are sealed by means of plastic plugs. Cable glands are not supplied. The opening on the other side is provided with a cover flange.

Dimensions for terminal box

Motor size	Dimensions		
	HB	HD	HE
Code 019: Larger than standard terminal box			
200 ML	332.5	603	240
225 SM	353	578	260.5
250 SM	376	626	283.5
Code 021: Terminal box on left-hand side seen from D end			
Code 180: Terminal box on right-hand side seen from D end			
200 ML	332	532	239
225 SM	354	579	260.5
250 SM	377	627	284

Refer to the Dimension drawings section for dimensions HB, HD and HE.

Connections

—
01 Terminal board for
motor sizes 56-80
56-63 gen F
71-80 gen E
80 gen K

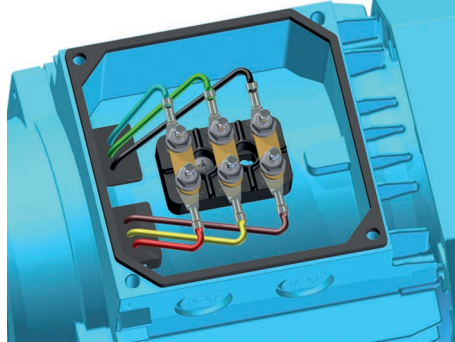

02 Terminal board for
motor sizes 90 to 112
gen E

03 Terminal board for
motor sizes 90-132
90 gen K
100 gen K
112 gen K
132 gen E

04 Terminal board for
motor sizes 132-180
132 gen K
160 gen G and K
180 gen G and K

05 Terminal board for
motor sizes 200 to 250 in
G and K-generation

—
01

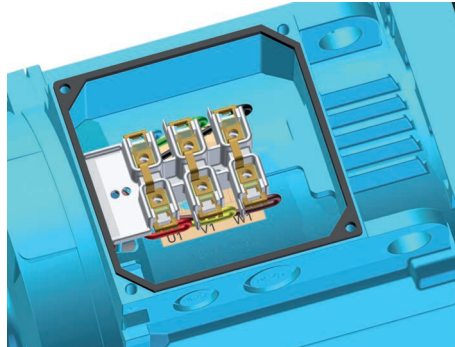

—
02

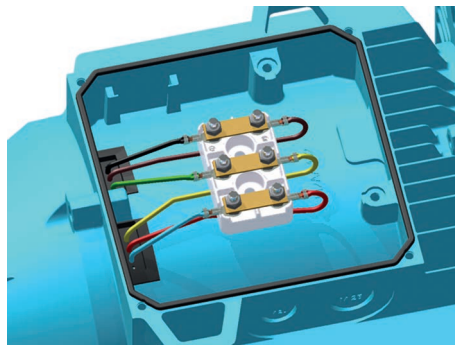

—
03

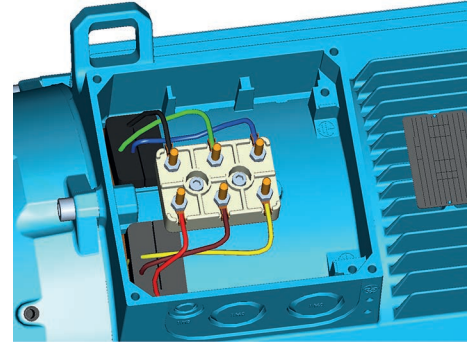

—
04

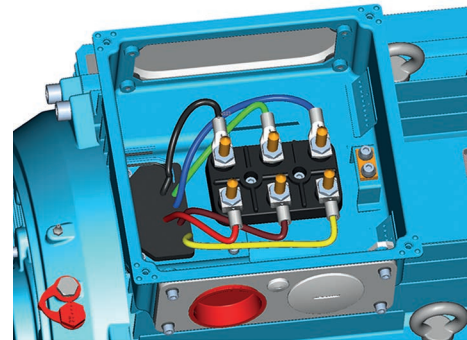

—
05

The terminal block is provided with six terminals for connecting Cu-cable. The terminals are marked in accordance with IEC 60034-8.

Connection openings

Motor size	Opening	Metric cable entry	Method of connection	Terminal bolt size	Maximum connectable Cu-cable area, mm ²
56-63	Knock-out opening	2x(M16+M16)	Cable lug	M4	2.5
71-80	Knock-out opening	2 x (2 x M20)	Cable lug	M4	4
90-112 Gen. E	Knock-out opening	2 x (M25 + M20)	Screw terminal	M4	6
90-112 Gen. K	Knock-out opening	2 x (M25 + M20)	Cable lug	M5	10
132 ¹⁾	Knock-out opening	2 x (M25 + M20)	Cable lug	M5	10
132 ²⁾	Knock-out opening	2 x (M40 x M32 + M12)	Cable lug	M6	35
160-180	Knock-out opening	2 x (2 x M40) + M16	Cable lug	M6	35
200-250	2 x FL 13	2 x M40 + M16	Cable lug	M10	70

¹⁾ All types except ²⁾

²⁾ SM_

Earthing (VC067)

Motor size	Earthing on frame	Earthing in terminal box
56-63	M4 (use self tapping screw)	M4 (use self tapping screw)
71-100	-	M4 (use self tapping screw)
112	-	M5 (use self tapping screw)
132	-	M5 (use self tapping screw)
160-180	-	M6 (use self tapping screw)
200-250	-	M6 (bracket)

Dimension drawings

Process performance IE3 aluminum motors

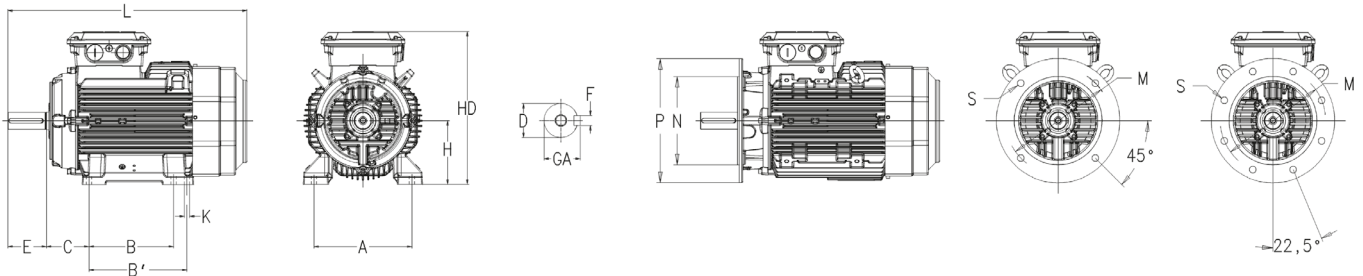

Foot-mounted motor IM1001, B3 and flange-mounted motor IM3001, B5

Motor size	Poles	D	GA	F	E	L max	A	B	B1	HD	HD	K	M	N	P	S
80	MB2, MC2	19	21.5	6	40	265.5	125	100		50	193.5	10	165	130	200	12
80	ME4	19	21.5	6	40	293.5	125	100		50	193.5	10	165	130	200	12
90	2-6	24	27	8	50	331.5	140	125		56	217	10	165	130	200	12
100	2-6	28	31	8	60	432	160	140		63	237	12	215	180	250	15
112	2-6 ¹⁾	28	31	8	60	431	190	140		70	260	12	215	180	250	15
112	4 ²⁾	28	31	8	60	477	190	140		70	260	12	215	180	250	15
132	2-6 ¹⁾	38	41	10	80	487	216	140	178	89	298	12	265	230	300	14.5
132	2-4 ^{3), 4)}	38	41	10	80	550	216	140	212	89	321	12	265	230	300	14.5
132	4 ⁵⁾	38	41	10	80	590	216	140	212	89	321	12	265	230	300	14.5
160	MLA 2-6, MLB2	42	45	12	110	584	254	210	254	108	370	15	300	250	350	19
160	MLB 4-6, MLC 2-6, MLD 2-4	42	45	12	110	681	254	210	254	108	370	15	300	250	350	19
180	2-6	48	51.5	14	110	726	279	241	279	121	405	15	300	250	350	19
200	2-6	55	59	16	110	821	318	267	305	133	532	18	400	350	400	19
225	2	55	59	16	110	850	356	286	311	149	553	18	400	350	450	19
225	4-6	60	64	18	140	880	356	286	311	149	553	18	400	350	450	19
250	2	60	64	18	140	884	406	311	349	168	601	22	500	450	550	19
250	4-6	65	69	18	140	884	406	311	349	168	601	22	500	450	550	19

¹⁾ all types except ²⁾ 4p 5,5kW (HO) ³⁾ 2p 11/15kW (HO)

⁴⁾ 4p 11kW (HO) ⁵⁾ 4p 15kW (HO)

IMB14 (IM3601)

Motor size	M	N	P	S	Motor size	M	N	P	S
63	75	60	90	5	100	130	110	160	8
71	85	70	105	6	112	130	110	160	8
80	100	80	120	6	132	165	130	200	10
90	115	95	140	8	132SM_	165	130	200	10

Tolerances		Tolerances	
A, B	±0,8	F	ISO h9
	ISO j6 ≤ Ø 28 mm	H	-0,5
D	ISO k6 < Ø 38 mm	N	ISO js6
	ISO m6 ≥ Ø 55 mm	C	±0,8

The table gives the main dimension in mm. For detailed drawings please see our web pages new.abb.com/motors-generators.

Dimension drawings

Process performance IE2 aluminum motors

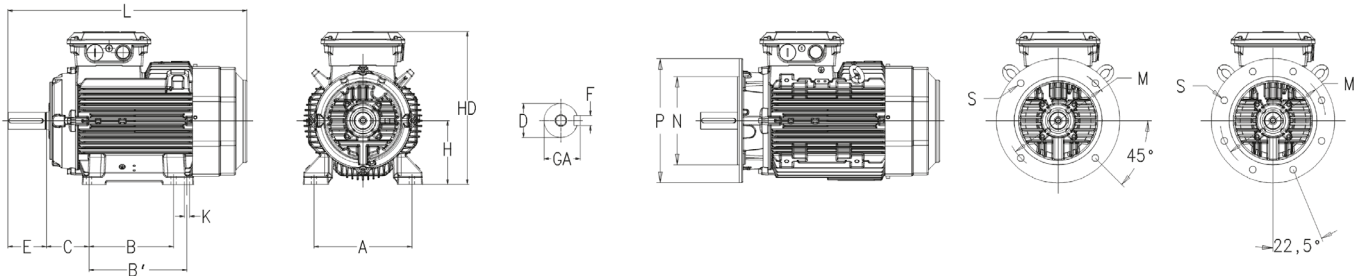

Foot-mounted motor IM1001, B3 and flange-mounted motor IM3001, B5

Motor size	Poles	D	GA	F	E	L max	A	B	B1	C	HD	K	M	N	P	S
56		9	10.4	3	20	183	90	71		36	56	143	100	80	120	7
63		11	12.5	4	23	208	100	80		40.1	154	7.5	115	95	140	10
71		14	12.5	5	30	240	112	90		45	180	7	130	110	160	10
80		19	21.5	6	40	265.5	125	100		50	193.5	10	165	130	200	12
90	L2, L8, LB 2-6	24	27	8	50	309.5	140	125		56	217	10	165	130	200	12
90	LD 4-6	24	27	8	50	331.5	140	125		56	217	10	165	130	200	12
100	LB2, LC 4-6	28	31	8	60	351	160	140		63	237	12	215	180	250	15
100	LD 4	28	31	8	60	373	160	140		63	237	12	215	180	250	15
112		28	31	8	60	393	190	140		70	249	12	215	180	250	15
132	SB2, M4, MA4, MBA4	38	41	10	80	447	216	140	178	89	295.5	12	265	230	300	14.5
132	SC2, MC6	38	41	10	80	487	216	140	178	89	295.5	12	265	230	300	14.5
132	SM_	38	41	10	80	550	216	140	178	89	321	12	265	230	300	14.5
160	MLA 2-6, MLB2	42	45	12	110	584	254	210	254	108	370	15	300	250	350	19
160	MLB 4-6, MLC 2-6, MLD 2-4	42	45	12	110	681	254	210	254	108	370	15	300	250	350	19
180	MLA 2-6, MLB 2-6, MLC4	48	51.5	14	110	726	279	241	279	121	405	15	300	250	350	19
200	MLA 2-6, MLB 2-6, MLC 2-6, MLD 2	55	59	16	110	821	318	267	305	133	532	18	400	350	400	19
225	SMA 2, SMB 2, SMC 2, SMD 2	55	59	16	110	850	356	286	311	149	579	18	400	350	450	19
225	SMA 4-6, SMB 4-6, SMC 4-6, SMD 4	60	63	18	140	880	356	286	311	149	579	18	400	350	450	19
250	SMA 2, SMB 2, SMC 2	60	64	18	140	884	406	406	349	168	627	22	500	450	550	19
250	SMA 4-6, SMB 4-6, SMC 4-6	65	69	18	140	884	406	406	349	168	627	22	500	450	550	19

IMB14 (IM3601)

Motor size	M	N	P	S	Motor size	M	N	P	S
63	75	60	90	5	100	130	110	160	8
71	85	70	105	6	112	130	110	160	8
80	100	80	120	6	132	165	130	200	10
90	115	95	140	8	132SM_	165	130	200	10

Tolerances		Tolerances	
A, B	±0,8	F	ISO h9
	ISO j6 ≤ Ø 28 mm	H	-0,5
D	ISO k6 < Ø 38 mm	N	ISO js6
	ISO m6 ≥ Ø 55 mm	C	±0,8

The table gives the main dimension in mm. For detailed drawings please see our web pages new.abb.com/motors-generators.

Accessories

Slide rails for motor sizes 160 to 250

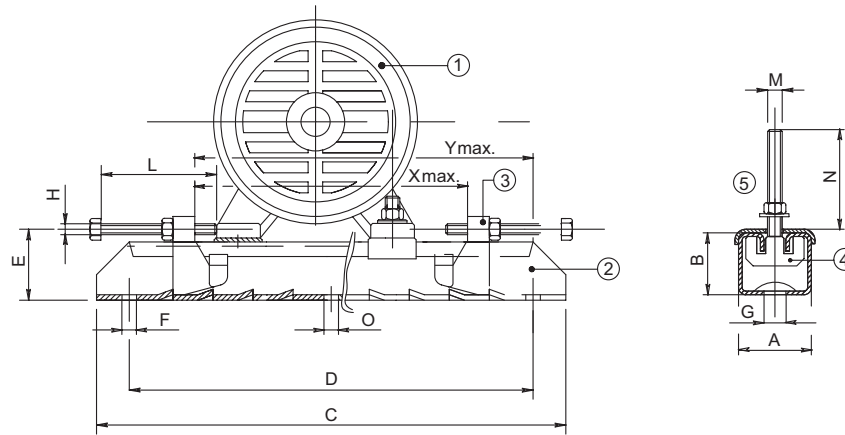

1 Motor | 2 Rail | 3 Movable adjusting bolt | 4 Fixing bolt, motor | 5 Plate

Motor size	Type	Product code 3GZV103001-	A	B	C	D	E	F	G	H	L	M	N	O	Xmax	Ymax	Weight (kg)
160-180	TT180/12	-14	75	42	700	630	57	17	26	M12	120	M12	50	-	520	580	12.0
200-225	TT225/16	-15	82	50	864	800	68	17	27	M16	140	M16	65	17	670	740	20.4
250	TT280/20	-16	116	70	1072	1000	90	20	27	M18	150	M20	80	20	870	940	43.0

¹⁾ Smaller sizes on request.

Each set includes two complete slide rails including screw for mounting the motor on the rails. Screws for mounting the rails on the foundation are not included. Slide rails are supplied with unmachined lower surfaces and should, prior to tightening down, be supported in a suitable manner.

Motors in brief

Aluminum motors, sizes 56 - 132

Motor size	M3AA	56-63	71	80	90	100	112	132
Stator and end shields	Material	Die-cast aluminum alloy						
	Paint colour shade	Munsell blue 8B 4.5/3.25						
	Corrosion class	C3 according to IEO/EN 12944-5						
Feet	Integrated aluminum feet							
Bearings	D-end	6201-2Z/C3	6203-2Z/C3	6204-2Z/C3	6205-2Z/C3	6306-2Z/C3	6306-2Z/C3	6208-2Z/C3 6308-2Z/C3 ¹⁾ E2.6208-2Z/C3 ²⁾ E2.6308-2Z/C3 ³⁾
	N-end	6201-2Z/C3	6202-2Z/C3	6203-2Z/C3	6204-2Z/C3	6205-2Z/C3	6205-2Z/C3	6206-2Z/C3 E2.6206-2Z/C3 ⁴⁾
Axially-locked bearings	Inner bearing cover	ND-end re- taining ring	Locked at D-end					
Bearing seal	D-end	V-ring						
	N-end	Labyrinth seal						
Lubrication	Permanent grease lubrication. Grease temperature range -40°C to +160°C							
Measuring nipples for condition monitoring of the bearings	Not included							
Rating plate	Material	Aluminum						
Terminal box	Material	Die-cast aluminum alloy, integrated to stator						
	Cover screws material	Zinc-electroplated steel						
Connections	Openings	2x(M16+M16)	2x(M20 + M20)	2x(M20+M25)			2x(M20+M25) ⁵⁾ 2x(M40+M32+M12) ⁶⁾	
		Knock-out						
	Terminals	6 terminals for connection with cable lugs (not included)						
	Cable glands	Optional						
Fan	Material	Glass-fiber reinforced polypropylene						
Fan cover	Material	Polypropylene						
	Paint colour shade	Munsell blue 8B 4.5/3.25						
	Corrosion class	C3						
Stator winding	Material	Copper						
	Insulation	Insulation class F						
	Winding protection	Optional					(Standard for IE3 motors in sizes 100-132)	
Rotor winding	Material	Die-cast aluminum						
Balancing	Half key balancing							
Key ways	Closed key way							
Drain holes	Without drain holes	Drain holes with closable plastic plugs, open on delivery						
External earthing bolt	As option							
Enclosure	IP 55							
Cooling method	IC 411							

¹⁾ (SM) except 4p 11&15kW HO

⁴⁾ HO 2p 9,2&15kW

²⁾ 2p 9,2kW HO

⁵⁾ S, SB, M, MA

³⁾ 2p 15kW HO

⁶⁾ SC, MC, SMA-SME

Motors in brief

Aluminum motors, sizes 160 - 250

Motor size	M3AA	160	180	200	225	250
Stator	Material	Die-cast aluminum alloy		Extruded aluminum alloy		
	Paint colour shade	Munsell blue 8B 4.5/3.25				
	Corrosion class	C3 according IEO/EN 12944-5				
End shields	Material	Cast iron				
Feet		Separate aluminum feet		Separate cast iron feet		
Bearings	D-end	6309-2Z/C3	6310-2Z/C3	6312-2Z/C3	6313-2Z/C3	6315-2Z/C3
	N-end	6209-2Z/C3	6209-2Z/C3	6210-2Z/C3	6212-2Z/C3	6213-2Z/C3
Axially-locked bearings	Inner bearing cover	Locked at D-end				
Bearing seal	D-end	Axial seal				
	N-end	Axial seal				
Lubrication		Permanently lubricated shielded bearings				
Measuring nipples for condition monitoring of the bearings		Not included				
Rating plate	Material	Aluminum				
Terminal box	Material	Die-cast aluminum alloy, integrated to stator		Deep-drawn steel sheet, bolted to stator		
	Cover screws material	Zinc-electroplated steel				
	Openings	2x(2xM40+M16)		2xFL13, 2xM40 + 1xM16		
Connections		Knock-out				
	Terminals	6 terminals for connection with cable lugs (not included)				
	Cable glands	Optional				
Fan	Material	Glass-fiber reinforced polypropylene				
Fan cover	Material	Steel				
	Paint colour shade	Munsell blue 8B 4.5/3.25				
	Corrosion class	C3				
Stator winding	Material	Copper				
	Insulation	Insulation class F				
	Winding protection	3 PTC thermistors, 150 °C, (standard for IE3 motors in sizes 160-250)				
Rotor winding	Material	Die-cast aluminum				
Balancing		Half key balancing				
Key ways		Closed key way				
Drain holes		Drain holes with closable plastic plugs, open on delivery				
External earthing bolt		As option				
Enclosure		IP 55				
Cooling method		IC411				

¹⁾ SC, MC, SMA-SME

²⁾ 4-6 poles

Low voltage Process performance aluminum Ex ec & Ex t motors

Sizes 90 to 250, 1.1 to 90 kW

58	Introduction to explosive atmospheres
60	Ordering information
61	Rating plates
62	Technical data IE3, 400 V 50 Hz
65	Technical data IE3, 460 V 60 Hz
68	Variant codes
71	Dimension drawings
72	Aluminum motors in brief
72	Motor sizes 90 - 132
73	Motor sizes 160 - 250

Introduction to explosive atmospheres

01 Zones - IECEx and ATEX

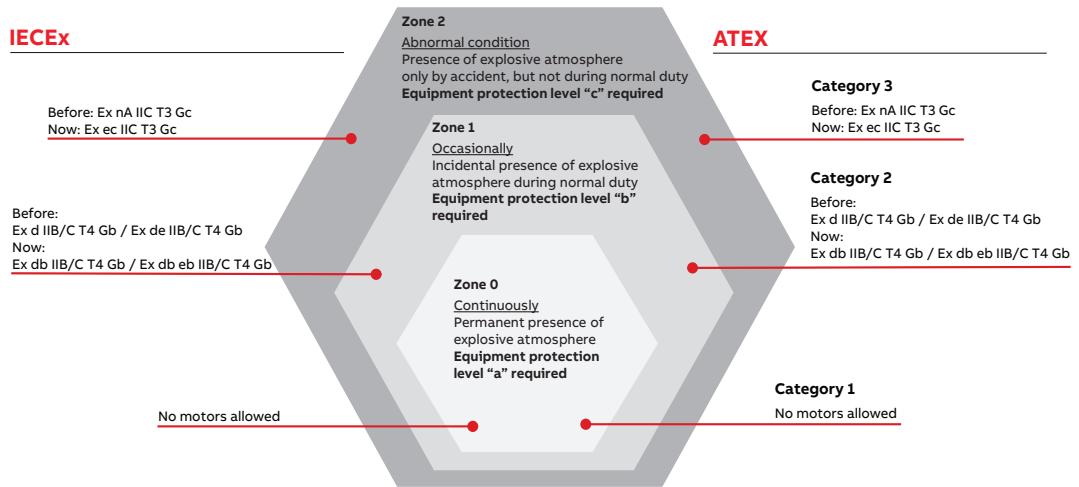

01

There are systems in place worldwide to classify explosive atmospheres by zones, according to the risk posed by explosive gas (“G”) or dust (“D”).

Classification of explosive atmospheres according to CENELEC and IEC

The following standards define areas according to the presence of gas or dust in the atmosphere:

- IEC/EN 60079-10-1 Gas
- IEC/EN 60079-10-2 Dust

Standard IEC 60079-0 EN 60079-0 Group	EPL	Protection level	Installation Zone acc. to IEC 60079-10-x EN 60079-10-x Zones	ATEX Directive 2014/34/EU Equipment group	Equipment category	Main motor protection types
I (Mines)	Ma	very high	NA	I (Mines)	M1	NA
	Mb	high			M2	
II (Gas)	Ga	very high	0	II (Surface)	1G	NA
	Gb	high	1		2G	Ex d/Ex de Ex p, Ex db, Ex db eb, Ex p, Ex eb (Ex e)
	Gc	enhanced	2		3G	Ex ec (Ex nA)
III (Dust)	Da	very high	20		1D	NA
	Db	high	21		2D	Ex tb IP 65
	Dc	enhanced	22		3D	Ex tc IP 65/IP 55

European ATEX Directives

The ATEX Directives harmonize safety rules in line with the free trading principles of the European Community.

Responsibilities are split between the manufacturers and end users. Manufacturers have to comply with the “Essential Health and Safety Requirements” of the Products Directive 2014/34/EU and end users must prepare an Explosion Protection Document based on risk assessments of their “work places” and “work equipment” to fulfill the “minimum requirements” listed in the Worker Protection Directive 1999/92/EC.

ABB low voltage motors for explosive atmospheres comply fully with the ATEX Product Directive.

According to the regulations, low voltage motors for explosive atmospheres are exempted from the Low Voltage Directive, the EMC Directive and the Machinery Directive.

IECEx System

The IECEx System is a certification system which verifies compliance with IEC (International Electrotechnical Commission) standards relating to safety in explosive atmospheres. It covers equipment, service facilities and personnel competencies and conformity mark licensing system.

Created in September 1999, the System aims “to facilitate international trade in equipment and services for use in explosive atmospheres, while maintaining the required level of safety...” (source: IECEx website, www.iecex.com). It is a voluntary

system which provides an internationally accepted means of proving that products and services are in compliance with IEC standards. The voluntary and international aspects of the IECEx System differentiate it from certification under ATEX, for example, which is mandatory but applies only within the European Economic Area.

The IECEx System comprises global certification programs for both equipment and service facilities.

IECEx certification involves – in addition to product tests – assessment of quality control procedures and testing plans, audits of manufacturing plants, and routine on-going surveillance and inspections.

In addition, IECEx has established a comprehensive set of operational documents and procedures to develop a single internationally standardized approach to Ex testing and certification.

IECEx certification is particularly useful in certain markets. In Australia, New Zealand, and Singapore, for example, IECEx certificates are accepted, but not all IEC certificates are accepted. Certain other countries, including Russia, China and Korea, are prepared to accept ExTRs as a basis for their own national certificates. There are also many countries that are willing to accept products covered by current IECEx certificates, even though the countries in question are not members of the IECEx Management Framework.

More information from the following catalogs:

- [Low voltage Motors for explosive gas atmospheres](#)
- [Low voltage Motors for explosive dust atmospheres](#)

Ordering information

Explanation of the product code

Motor type	Motor size	Product code	Code for mounting arrangement, Voltage and frequency code, Generation code followed by variant codes
M3AA	132MC	3GAA 132	330 - BDK338, 003 etc.
		1 2 3 4 5 6 7 8 9 10 11 12 13 14...	

Explanation of the product code

Motor type	Motor size	Product code	Code for mounting arrangement, Voltage and frequency code, Generation code followed by variant codes
M3AA	160ML	3GAA 163	420 - ADK, 531 etc.
		1 2 3 4 5 6 7 8 9 10 11 12 13 14...	

Positions 1 to 4

3GAA: Totally enclosed motor with aluminum stator frame

Positions 5 and 6

IEC size

09:	90
10:	100
11:	112
13:	132
16:	160
18:	180
20:	200
22:	225
25:	250

Position 7

Pole pairs

1:	2 poles
2:	4 poles
3:	6 poles

Positions 8 to 10

Running number

Position 11

- (dash)

Position 12 (marked with black dot in data tables)

Mounting arrangement

A:	Foot-mounted motor
B:	Flange-mounted motor. Large flange with clearance holes.
C:	Flange-mounted motor. Small flange with tapped holes.
H:	Foot- and flange-mounted motor. Large flange with clearance holes.
J:	Foot- and flange-mounted motor. Small flange with tapped holes.

Position 13 (marked with black dot in data tables)

Voltage and frequency code

Single-speed motors

D:	400 VΔ, 415 VΔ, 690 VY 50 Hz
S:	230 VΔ, 400 VY, 415 VY 50 Hz

Position 14

Version

A, B, C...: Generation code followed by variant codes

Efficiency values are given according to IEC 60034-2-1; 2014.

* Not as standard offering, can be ordered as customer-specific solution.

Rating plates

ABB Oy, Motors and Generators
Strömbergin puistotie 5 A
65320 Vaasa, Finland

CE IEC60034-1 Ex II 3GD

3~ MOTOR M3AA 132MC 4 IMB5(IM3001) 2022

Ex ec IIC T3 Gc/ Ex tc IIIB T125° C Dc

MP1732678-11

No. 3G1P223301259 Ins. cl. F IP 55

V	Hz	kW	r/min	A	cosΦ	Duty
690 Y	50	7.5	1464	8.5	0.81	S1
400 D	50	7.5	1464	14.7	0.81	S1
660 Y	50	7.5	1456	8.8	0.83	S1
380 D	50	7.5	1456	15.3	0.83	S1
415 D	50	7.5	1465	14.4	0.79	S1
460 D	60	7.5	1766	13	0.79	S1

IE3-50Hz-90.4%(100%)-90.5%(75%)-90.1%(50%)/IE3-60Hz-91.7%(100%)

Product code 3GAA132330-BDK338

EESF 20 ATEX 073X

Manual: 3GZF500730-47 Nmax r/min

6208-2RS/C3 6206-2RS/C3 68 kg

ABB Oy, Motors and Generators
Strömbergin puistotie 5 A
65320 Vaasa, Finland

CE IEC60034-1 Ex II 3D

3~ MOTOR M3AA 160MLB 6 IMB3(IM1001) 2023

Ex tc IIC IIIB T125° C Dc

2139448-10

No. 3G1P2326600641 Ins. cl. F IP 55

V	Hz	kW	r/min	A	cosΦ	Duty
690 Y	50	11	979	13.6	0.74	S1
400 D	50	11	979	23.5	0.74	S1
660 Y	50	11	976	13.8	0.77	S1
380 D	50	11	976	23.8	0.77	S1
415 D	50	11	981	23.6	0.71	S1
460 D	60	11	1183	20.6	0.73	S1

IE3-50Hz-90.3%(100%)-90.4%(75%)-89.2%(50%)/IE3-60Hz-91.7%(100%)

Product code 3GAA163420-ADK + VC

EESF 20 ATEX 073X

Manual: 3GZF500730-47 Nmax r/min

6309-2Z/C3 6209-2Z/C3 139 kg

- 1 ABB logo
- 2 Manufacturing place
- 3 CE mark on Ecodesign approved motors
- 4 Manufacturing standard
- 5 Product description
- 6 Manufacturing year
- 7 Factory order reference number
- 8 Serial number
- 9 Insulation class, IP protection class
- 10 Voltage, Frequency, output, speed, current, power factory, duty
- 11 Product code
- 12 Bearing type
- 13 Weight

Technical data, 400 V 50 Hz

IE3 Increased safety Ex ec & Ex t aluminum motors

IP 55 - IC 411 - Insulation class F, temperature rise class B
IE3 efficiency class according to IEC 60034-30-1: 2014

Output kW	Motor type	Product code	Speed r/min	Efficiency IEC 60034-30-1: 2014			Power factor Cos ϕ	Current		Torque		Moment of inertia J = 1/4 GD ² kgm ²	Weight kg	Sound pressure Level L _{PA} dB	
				Full load 100%	3/4 load 75%	1/2 load 50%		I _N A	I _s /I _N	T _N Nm	T _i /T _N				T _b /T _N
3000 r/min = 2 poles			400 V 50 Hz			CENELEC-design									
1.5	M3AA 90LB 2	3GAA091520--K	2906	84.2	84.8	84.7	0.89	2.8	7.9	4.9	2.3	3.3	0.0027	17	60
2.2	M3AA 90LC 2	3GAA091530--K	2900	85.9	87.4	87.5	0.89	4	8.3	7.2	2.9	3.5	0.0032	20	60
3	M3AA 100LC 2	3GAA101530--K	2896	87.1	88.2	88.0	0.90	5.4	8.4	9.8	3.2	3.9	0.0057	28	62
4	M3AA 112MB 2	3GAA111320--K	2888	88.1	89.4	89.6	0.91	7.1	8.4	13.2	3.2	4.0	0.0104	38	68
5.5	M3AA 132SB 2	3GAA131120--K	2901	89.2	89.9	90.1	0.91	9.7	7.9	18.1	2.3	3.4	0.0154	58	68
7.5	M3AA 132SC 2	3GAA131130--K	2909	90.1	91.2	91.4	0.90	13.1	8.3	24.6	3.0	3.9	0.0173	63	70
11	M3AA 160MLA 2	3GAA161410--K	2943	91.2	92.0	91.6	0.91	19.1	7.2	35.57	2.6	3.6	0.057	106	69
15	M3AA 160MLB 2	3GAA161420--K	2947	91.9	92.2	91.8	0.88	26.7	8.2	48.6	3.2	4.2	0.063	123	69
18.5	M3AA 160MLC 2	3GAA161430--K	2949	92.4	93.0	92.6	0.90	32.1	9.0	59.9	3.3	3.9	0.076	137	73
22	M3AA 180MLA 2	3GAA181410--K	2956	92.7	93.1	92.7	0.90	37.7	7.8	71.0	3.0	3.8	0.11	176	73
30	M3AA 200MLA 2	3GAA201410--K	2962	93.3	93.5	92.8	0.87	53.2	7.6	96.8	3.1	3.8	0.159	225	72
37	M3AA 200MLB 2	3GAA201420--K	2961	93.7	94.1	93.8	0.88	64.4	8.2	119	3.0	3.3	0.196	241	72
45	M3AA 225SMA 2	3GAA221210--K	2968	94.0	94.0	93.0	0.87	79.6	7.3	145	3.2	3.1	0.296	326	76
55	M3AA 250SMA 2	3GAA251210--K	2968	94.3	93.7	93.6	0.89	94.8	6.8	177	2.4	3.0	0.426	351	76

Output kW	Motor type	Product code	Speed r/min	Efficiency IEC 60034-30-1: 2014			Power factor Cos ϕ	Current		Torque		Moment of inertia J = 1/4 GD ² kgm ²	Weight kg	Sound pressure Level L _{PA} dB	
				Full load 100%	3/4 load 75%	1/2 load 50%		I _N A	I _s /I _N	T _N Nm	T _i /T _N				T _b /T _N
3000 r/min = 2 poles			400 V 50 Hz			High-output design									
2.75	M3AA 90LD 2	3GAA091540--K	2872	87.1	88.2	88.0	0.83	5.4	7.5	9.1	4.4	5.0	0.00407	20	65
4	M3AA 100LD 2	3GAA101540--K	2910	88.1	89.7	89.7	0.91	7.12	8.6	13.1	3.9	4.8	0.00787	40	67
5.5	M3AA 112MC 2	3GAA111330--K	2909	89.2	90.6	90.8	0.91	9.67	8.6	18.1	4.3	5.5	0.0132	48	73
9.2	M3AA 132SD 2	3GAA131140--K	2910	90.7	91.7	91.7	0.90	15.9	8.2	29.9	3.4	4.3	0.0168	71	75
11	M3AA 132SME 2	3GAA131250--K	2922	91.2	91.8	91.5	0.90	19.8	10.6	36.0	4.5	5.4	0.0231	90	75
15	M3AA 132SMF 2	3GAA131260--K	2908	91.9	93.2	93.5	0.91	25.8	9.8	49.3	4.4	5.5	0.023	90	75
22	M3AA 160MLD 2	3GAA161440--K	2944	92.7	93.5	93.4	0.90	38	8.4	71.4	3.2	3.7	0.071	131	74
30	M3AA 180MLB 2	3GAA181420--K	2957	93.3	94.0	93.9	0.88	52.7	8.7	96.9	3.0	3.8	0.104	162	74
37	¹⁾ M3AA 180MLC 2	3GAA181430--K	2950	93.7	94.2	94.2	0.86	66	8.4	119.5	3.4	4.4	0.117	176	74
45	M3AA 200MLC 2	3GAA201430--K	2956	94.0	94.6	94.8	0.89	77.2	7.8	145.2	2.9	3.3	0.216	250	77
55	M3AA 225SMB 2	3GAA221220--K	2964	94.3	94.4	93.9	0.86	97.4	7.2	177.3	3.14	3.22	0.299	288	79
75	¹⁾ M3AA 225SMC 2	3GAA221230--K	2966	94.7	95	94.7	0.86	132	7.5	241.7	3.08	3.06	0.361	328	79
75	¹⁾ M3AA 250SMB 2	3GAA251220--K	2971	94.7	95.1	94.8	0.90	127	7.9	241.1	2.8	3.3	0.644	405	81
90	¹⁾ M3AA 250SMC 2	3GAA251230--K	2975	95	95.2	94.6	0.87	156	8.5	288.6	2.91	3.6	0.514	414	81

¹⁾ Temperature rise class F

Frame sizes 90-132 are available as premodified motors with following variant codes:

- 338 - Rated for gas or dust, Ex ec IIC T3 Gc / Ex tc IIIB T125C Dc (non-conductive dust), IP5X
- 339 - Rated for gas or dust, Ex ec IIC T3 Gc / Ex tc IIIC T125C Dc (conductive dust), IP6X.

When ordering frame sizes 160-250, select appropriate variant code:

- 335 - Ex t, Dust group III B T125C Dc, IP5X
- 336 - Ex t, Dust group III C T125 Db, IP6X
- 456 - Ex ec IIC T3 Gc acc. IEC/EN 60079-7

Technical data, 400 V 50 Hz

IE3 Increased safety Ex ec & Ex t aluminum motors

IP 55 - IC 411 - Insulation class F, temperature rise class B
IE3 efficiency class according to IEC 60034-30-1: 2014

Output kW	Motor type	Product code	Speed r/min	Efficiency IEC 60034-30-1: 2014			Power factor Cos ϕ	Current		Torque		Moment of inertia J = 1/4 GD ² kgm ²	Weight kg	Sound pressure Level L _{PA} dB	
				Full load 100%	3/4 load 75%	1/2 load 50%		I _N A	I _S /I _N	T _N Nm	T _I /T _N				T _B /T _N
1500 r/min = 4 poles				400 V 50 Hz			CENELEC-design								
1.1	M3AA 90LC 4	3GAA092530-**-K	1442	84.1	83.5	81.7	0.80	2.3	7.9	7.2	3.3	3.9	0.0055	19	56
1.5	M3AA 90LD 4	3GAA092540-**-K	1439	85.3	84.7	82.8	0.78	3.2	8.2	9.9	3.5	4.0	0.0055	19	51
2.2	M3AA 100LE 4	3GAA102550-**-K	1454	86.7	87.1	86.0	0.83	4.3	8.9	14.5	3.1	4.1	0.0144	36	54
3	M3AA 100LF 4	3GAA102560-**-K	1452	87.7	88.1	87.1	0.83	5.9	9.0	19.7	3.5	4.2	0.0144	36	54
4	M3AA 112MB 4	3GAA112320-**-K	1451	88.6	89.4	89.0	0.77	8.6	7.6	26.3	3.1	4.1	0.018	44	59
5.5	M3AA 132MB 4	3GAA132320-**-K	1464	89.6	90.2	89.5	0.78	11.4	7.0	35.9	2.8	3.9	0.0295	68	70
7.5	M3AA 132MC 4	3GAA132330-**-K	1464	90.4	90.8	90.7	0.81	14.7	7.7	48.9	2.5	3.6	0.0414	68	64
11	M3AA 160MLA 4	3GAA162410-**-K	1477	91.4	91.8	91.1	0.82	21.1	7.6	71.3	2.6	3.3	0.11	126	61
15	M3AA 160MLB 4	3GAA162420-**-K	1474	92.1	92.2	91.3	0.81	29	7.8	97.2	3.0	3.6	0.135	140	61
18.5	M3AA 180MLA 4	3GAA182410-**-K	1481	92.6	93.2	92.9	0.83	34.9	7.2	119.3	2.8	3.0	0.219	177	60
22	M3AA 180MLB 4	3GAA182420-**-K	1480	93.0	93.8	93.8	0.82	41.5	8.2	141.0	2.8	3.1	0.217	176	62
30	M3AA 200MLA 4	3GAA202410-**-K	1481	93.6	93.9	93.4	0.84	55	7.5	193.4	2.7	3.2	0.385	246	63
37	M3AA 225SMA 4	3GAA222210-**-K	1481	93.9	94.1	93.4	0.82	69.8	8.0	235.4	3.3	3.5	0.433	315	67
45	M3AA 225SMB 4	3GAA222220-**-K	1482	94.2	94.4	94.0	0.84	82.3	8.0	290.0	3.1	3.5	0.525	316	66
55	M3AA 250SMA 4	3GAA252210-**-K	1485	94.6	95.2	94.9	0.85	97.8	7.9	353.0	3.0	3.3	0.933	376	67

Output kW	Motor type	Product code	Speed r/min	Efficiency IEC 60034-30-1: 2014			Power factor Cos ϕ	Current		Torque		Moment of inertia J = 1/4 GD ² kgm ²	Weight kg	Sound pressure Level L _{PA} dB	
				Full load 100%	3/4 load 75%	1/2 load 50%		I _N A	I _S /I _N	T _N Nm	T _I /T _N				T _B /T _N
1500 r/min = 4 poles				400 V 50 Hz			High-output design								
5.5	M3AA 112MC 4	3GAA112330-**-K	1454	89.6	90.0	88.6	0.78	11.2	8.0	39.2	3.9	4.3	0.0234	50	64
9.2	M3AA 132MD 4	3GAA132340-**-K	1464	91.0	91.7	91.3	0.80	18	8.5	60	3.0	4.0	0.0392	65	75
11	M3AA 132SME 4	3GAA132250-**-K	1464	91.4	92.0	91.6	0.79	21.8	8.2	71.56	3.1	4.1	0.0468	88	75
15	M3AA 132SMF 4	3GAA132260-**-K	1464	92.1	92.6	92.1	0.79	29.7	9.0	97.52	3.4	4.5	0.0545	88	75
18.5	M3AA 160MLC 4	3GAA162430-**-K	1476	92.6	93.1	92.7	0.77	37.2	8.3	119.9	3.3	3.6	0.12	135	67
28	M3AA 180MLC 4	3GAA182430-**-K	1482	93.4	93.3	92.3	0.77	56.5	8.2	180.4	3.0	3.6	0.191	176	62
37	¹⁾ M3AA 200MLB 4	3GAA202420-**-K	1482	93.9	94.1	93.7	0.82	69.3	7.8	237.9	3.1	3.3	0.362	244	68
53	M3AA 225SMC 4	3GAA222230-**-K	1483	94.5	94.7	94.2	0.83	97	8.7	341.34	3.15	3.41	0.532	318	71
75	M3AA 250SMB 4	3GAA252220-**-K	1483	95.0	95.3	95.0	0.82	139	7.8	485.8	3.28	3.46	0.796	389	73

¹⁾ Temperature rise class F

Frame sizes 90-132 are available as premodified motors with following variant codes:

- 338 - Rated for gas or dust, Ex ec IIC T3 Gc / Ex tc IIIB T125C Dc (non-conductive dust), IP5X
- 339 - Rated for gas or dust, Ex ec IIC T3 Gc / Ex tc IIIC T125C Dc (conductive dust), IP6X.

When ordering frame sizes 160-250, select appropriate variant code:

- 335 - Ex t, Dust group III B T125C Dc, IP5X
- 336 - Ex t, Dust group III C T125 Db, IP6X
- 456 - Ex ec IIC T3 Gc acc. IEC/EN 60079-7

Technical data, 400 V 50 Hz

IE3 Increased safety Ex ec & Ex t aluminum motors

IP 55 - IC 411 - Insulation class F, temperature rise class B

IE3 efficiency class according to IEC 60034-30-1: 2014

Output kW	Motor type	Product code	Speed r/min	Efficiency IEC 60034-30-1: 2014			Power factor Cos ϕ	Current		Torque		Moment of inertia J = 1/4 GD ² kgm ²	Weight kg	Sound pressure Level L _{PA} dB	
				Full load 100%	3/4 load 75%	1/2 load 50%		I _N A	I _S /I _N	T _N Nm	T _I /T _N				T _B /T _N
1000 r/min = 6 poles			400 V 50 Hz			CENELEC-design									
0.75	M3AA 90LD 6	3GAA093540-**K	937	78.9	79.6	77.3	0.76	1.78	4.6	7.6	2.1	2.3	0.0055	19	55
1.1	M3AA 100LE 6	3GAA103550-**K	963	81.0	82.2	81.0	0.69	2.6	5.6	10.9	2.3	3.1	0.0138	35	49
1.5	M3AA 100LF 6	3GAA103560-**K	969	82.5	81.4	77.5	0.65	3.7	7.0	14.7	3.3	4.1	0.0138	35	49
2.2	M3AA 112MC 6	3GAA113330-**K	967	84.3	85.2	84.1	0.69	5.2	6.5	21.7	2.4	3.5	0.0187	43	68
3	M3AA 132MC 6	3GAA133330-**K	978	85.6	86.0	84.5	0.69	7	6.2	29.2	2.0	3.0	0.0402	66	61
4	M3AA 132MD 6	3GAA133340-**K	973	86.8	87.7	87.5	0.72	9.1	5.6	39.2	1.9	2.7	0.0402	67	61
5.5	M3AA 132ME 6	3GAA133350-**K	973	88.0	88.8	88.2	0.74	12	5.8	53.9	2.0	2.9	0.039	63	61
7.5	M3AA 160MLA 6	3GAA163410-**K	980	89.1	89.9	89.3	0.78	15.2	7.9	73.0	1.7	3.3	0.114	125	59
11	M3AA 160MLB 6	3GAA163420-**K	979	90.3	90.9	90.2	0.74	23.5	8.5	107.0	2.2	3.9	0.131	139	59
15	M3AA 180MLA 6	3GAA183410-**K	987	91.2	91.5	90.5	0.77	30.4	5.5	146.0	1.7	2.7	0.225	175	59
18.5	M3AA 200MLA 6	3GAA203410-**K	990	91.7	92.1	91.5	0.77	37.3	7.5	178.0	2.6	3.2	0.448	218	63
22	M3AA 200MLB 6	3GAA203420-**K	990	92.2	92.7	92.0	0.79	43	7.8	212.0	2.6	3.2	0.531	245	63
30	M3AA 225SMA 6	3GAA223210-**K	989	92.9	93.6	93.3	0.81	56.8	7.9	289.0	2.8	3.1	0.813	310	63
37	M3AA 250SMA 6	3GAA253210-**K	991	93.3	93.9	93.6	0.83	68	7.7	356.0	2.7	2.9	1.49	367	63

Output kW	Motor type	Product code	Speed r/min	Efficiency IEC 60034-30-1: 2014			Power factor Cos ϕ	Current		Torque		Moment of inertia J = 1/4 GD ² kgm ²	Weight kg	Sound pressure Level L _{PA} dB	
				Full load 100%	3/4 load 75%	1/2 load 50%		I _N A	I _S /I _N	T _N Nm	T _I /T _N				T _B /T _N
1000 r/min = 6 poles			400 V 50 Hz			High-output design									
18.5	M3AA 180MLB 6	3GAA183420-**K	980	91.7	92.1	91.5	0.72	40.3	6.8	180	2.3	3.2	0.191	168	65
37	M3AA 225SMB 6	3GAA223220-**K	985	93.3	93.6	93.0	0.80	71.5	7.0	358.7	2.7	3.0	0.813	307	68
45	M3AA 250SMB 6	3GAA253220-**K	991	93.7	93.8	93.1	0.79	87.3	8.0	433.2	3.1	3.2	1.33	389	68

Frame sizes 90-132 are available as premodified motors with following variant codes:

- 338 - Rated for gas or dust, Ex ec IIC T3 Gc / Ex tc IIIB T125C Dc (non-conductive dust), IP5X
- 339 - Rated for gas or dust, Ex ec IIC T3 Gc / Ex tc IIIC T125C Dc (conductive dust), IP6X.

When ordering frame sizes 160-250, select appropriate variant code:

- 335- Ex t, Dust group III B T125C Dc, IP5X
- 336 - Ex t, Dust group III C T125 Db, IP6X
- 456 - Ex ec IIC T3 Gc acc. IEC/EN 60079-7

Technical data, 460 V 60 Hz

IE3 Increased safety Ex ec & Ex t aluminum motors

IP 55 - IC 411 - Insulation class F, temperature rise class B
IE3 efficiency class according to IEC 60034-30-1: 2014

Output kW	Motor type	Product code	Speed r/min	Efficiency IEC 60034-30-1: 2014			Power factor Cos ϕ	Current			Torque		Moment of inertia J = 1/4 GD ² kgm ²	Weight kg	Sound pressure Level L _{PA} dB
				Full load 100%	3/4 load 75%	1/2 load 50%		I _N A	I _S /I _N	T _N Nm	T _r /T _N	T _b /T _N			
				CENELEC-design											
3600 r/min = 2 poles				460 V 60 Hz											
1.5	M3AA 90LB 2	3GAA091520---K	3522	85.5	85.3	84.0	0.88	2.4	9.6	4.0	4.0	4.6	0.0027	17	65
2.2	M3AA 90LC 2	3GAA091530---K	3517	86.5	87.1	85.8	0.88	3.5	9.9	5.9	3.1	4.2	0.0032	20	65
3	M3AA 100LC 2	3GAA101530---K	3512	88.5	88.7	87.2	0.89	4.7	9.9	8.1	3.5	4.6	0.0057	28	65
4	M3AA 112MB 2	3GAA111320---K	3500	88.5	88.9	87.9	0.90	6.2	10.0	10.9	3.6	4.8	0.0104	38	71
5.5	M3AA 132SB 2	3GAA131120---K	3519	89.5	89.4	88.7	0.90	8.4	9.1	14.9	2.5	3.9	0.0154	58	74
7.5	M3AA 132SC 2	3GAA131130---K	3524	90.2	90.7	90.0	0.90	11.4	9.6	20.3	3.1	4.5	0.0173	63	73
11	M3AA 160MLA 2	3GAA161410---K	3549	91.0	91.1	89.9	0.91	16.6	8.7	29.5	2.7	3.9	0.057	106	75
15	M3AA 160MLB 2	3GAA161420---K	3554	91.0	90.4	89.6	0.89	23.2	8.5	40.3	3.8	4.8	0.063	123	74
18.5	M3AA 160MLC 2	3GAA161430---K	3555	91.7	91.9	90.7	0.89	28.4	10.5	49.7	3.8	4.7	0.076	137	75
22	M3AA 180MLA 2	3GAA181410---K	3560	91.7	91.7	90.4	0.89	33	9.2	59.0	4.1	4.7	0.11	176	77
30	M3AA 200MLA 2	3GAA201410---K	3567	92.4	92.2	91.0	0.87	46.1	9.0	80.3	3.2	4.0	0.159	225	76
37	M3AA 200MLB 2	3GAA201420---K	3564	93.0	92.8	91.2	0.88	56.7	9.2	99.1	3.1	3.7	0.196	241	76
45	M3AA 225SMA 2	3GAA221210---K	3570	93.6	93.1	91.5	0.89	67.4	7.8	120	3.3	3.7	0.296	326	79
55	M3AA 250SMA 2	3GAA251210---K	3569	93.6	93.1	91.6	0.90	82.7	7.9	147	2.3	3.3	0.426	351	81

Output kW	Motor type	Product code	Speed r/min	Efficiency IEC 60034-30-1: 2014			Power factor Cos ϕ	Current			Torque		Moment of inertia J = 1/4 GD ² kgm ²	Weight kg	Sound pressure Level L _{PA} dB
				Full load 100%	3/4 load 75%	1/2 load 50%		I _N A	I _S /I _N	T _N Nm	T _r /T _N	T _b /T _N			
				High-output design											
3600 r/min = 2 poles				460 V 60 Hz											
2.75	M3AA 90LD 2	3GAA091540---K	3497	86.5	87.4	86.3	0.82	4.69	7.1	8.0	4.2	5.1	0.00407	20	69
4	M3AA 100LD 2	3GAA101540---K	3523	88.5	89.4	88.5	0.91	6.2	10.9	10.8	5.0	5.4	0.00787	40	71
5.5	M3AA 112MC 2	3GAA111330---K	3523	89.5	88.1	87.1	0.89	8.4	11.2	15.0	5.4	6.8	0.0132	48	77
9.2	M3AA 132SD 2	3GAA131140---K	3525	90.2	90.4	89.3	0.90	13.9	9.1	24.9	4.0	4.8	0.0168	71	79
11	M3AA 132SME 2	3GAA131250---K	3527	91.0	90.8	89.3	0.89	16.7	12.1	29.8	4.7	6.2	0.0231	90	79
15	M3AA 132SMF 2	3GAA131260---K	3526	91.0	91.6	91.2	0.90	22.3	10.5	40.9	3.8	5.1	0.023	90	79
22	M3AA 160MLD 2	3GAA161440---K	3552	92.9	93.2	92.5	0.90	32.9	9.7	59.2	3.5	4.2	0.071	131	78
30	M3AA 180MLB 2	3GAA181420---K	3563	93.3	93.5	92.9	0.88	45.7	10.0	80.4	3.3	4.3	0.104	162	78
37	M3AA 180MLC 2	3GAA181430---K	3564	93.0	93.2	92.7	0.86	57	9.7	99.1	3.8	4.7	0.117	176	78
45	M3AA 200MLC 2	3GAA201430---K	3563	93.6	93.9	93.7	0.89	66.8	8.7	120.6	3.2	3.7	0.216	250	81
55	M3AA 225SMB 2	3GAA221220---K	3575	93.6	93.6	92.7	0.86	84.5	8.1	146.9	3.41	3.72	0.299	288	83
75	M3AA 225SMC 2	3GAA221230---K	3572	94.1	94.3	93.5	0.88	114	8.4	200.7	3.24	3.75	0.361	328	83
75	M3AA 250SMB 2	3GAA251220---K	3575	94.9	94.9	94.1	0.90	110	9.0	200.3	3.0	3.6	0.644	405	85
90	M3AA 250SMC 2	3GAA251230---K	3578	95.0	94.9	94.1	0.87	136	9.6	240	3.08	4.17	0.514	414	85

Frame sizes 90-132 are available as premodified motors with following variant codes:

- 338 - Rated for gas or dust, Ex ec IIC T3 Gc / Ex tc IIIB T125C Dc (non-conductive dust), IP5X
- 339 - Rated for gas or dust, Ex ec IIC T3 Gc / Ex tc IIIC T125C Dc (conductive dust), IP6X.

When ordering frame sizes 160-250, select appropriate variant code:

- 335 - Ex t, Dust group III B T125C Dc, IP5X
- 336 - Ex t, Dust group III C T125 Db, IP6X
- 456 - Ex ec IIC T3 Gc acc. IEC/EN 60079-7

Technical data, 460 V 60 Hz

IE3 Increased safety Ex ec & Ex t aluminum motors

IP 55 - IC 411 - Insulation class F, temperature rise class B

IE3 efficiency class according to IEC 60034-30-1: 2014

Output kW	Motor type	Product code	Speed r/min	Efficiency IEC 60034-30-1; 2014			Power factor Cos ϕ	Current		Torque		Moment of inertia J = 1/4 GD ² kgm ²	Weight kg	Sound pressure Level L _{PA} dB	
				Full load 100%	3/4 load 75%	1/2 load 50%		I _N A	I _s /I _N	T _N Nm	T _r /T _N				T _b /T _N
1800 r/min = 4 poles			460 V 60 Hz			CENELEC-design									
1.1	M3AA 90LC 4	3GAA092530---K	1749	86.5	85.4	82.5	0.77	2.0	8.4	6.0	3.7	4.6	0.0055	19	56
1.5	M3AA 90LD 4	3GAA092540---K	1748	86.5	85.1	82.0	0.75	2.9	9.5	8.1	4.0	5.0	0.0055	19	57
2.2	M3AA 100LE 4	3GAA102550---K	1760	89.5	89.2	87.4	0.81	3.8	10.2	11.9	3.3	4.7	0.0144	36	57
3	M3AA 100LF 4	3GAA102560---K	1759	89.5	89.3	87.4	0.81	5.2	10.4	16.3	3.8	4.9	0.0144	36	57
4	M3AA 112MB 4	3GAA112320---K	1755	90.1	90.5	89.5	0.75	7.43	9.3	21.74	3.46	4.91	0.018	44	62
5.5	M3AA 132MB 4	3GAA132320---K	1769	91.7	91.7	90.5	0.75	10	8.0	29.7	3.0	4.5	0.0295	68	73
7.5	M3AA 132MC 4	3GAA132330---K	1766	91.7	91.6	90.8	0.79	13	8.7	40.5	2.6	3.9	0.0414	68	69
11	M3AA 160MLA 4	3GAA162410---K	1780	92.4	92.2	90.9	0.80	18.9	8.7	59.1	3.4	3.7	0.11	126	68
15	M3AA 160MLB 4	3GAA162420---K	1777	93.0	92.6	91.2	0.79	25.7	8.9	80.6	3.3	4.1	0.135	140	67
18.5	M3AA 180MLA 4	3GAA182410---K	1783	93.6	93.7	92.9	0.82	30.3	8.4	99.0	3.1	3.5	0.219	177	68
22	M3AA 180MLB 4	3GAA182420---K	1783	93.8	94.2	93.7	0.82	35.8	9.3	117.0	3.0	3.4	0.217	176	66
30	M3AA 200MLA 4	3GAA202410---K	1783	94.1	94.0	93.0	0.83	48.2	8.5	160.6	2.8	3.9	0.385	246	69
37	M3AA 225SMA 4	3GAA222210---K	1786	94.5	94.4	93.5	0.81	61.2	8.4	195.2	3.8	4.0	0.433	315	65
45	M3AA 225SMB 4	3GAA222220---K	1784	95.0	94.9	95.0	0.83	71.8	8.8	241.2	2.9	4.7	0.525	316	72
55	M3AA 250SMA 4	3GAA252210---K	1787	95.7	95.8	95.2	0.84	85.8	9.1	293.0	3.3	3.7	0.933	376	71

Output kW	Motor type	Product code	Speed r/min	Efficiency IEC 60034-30-1; 2014			Power factor Cos ϕ	Current		Torque		Moment of inertia J = 1/4 GD ² kgm ²	Weight kg	Sound pressure Level L _{PA} dB	
				Full load 100%	3/4 load 75%	1/2 load 50%		I _N A	I _s /I _N	T _N Nm	T _r /T _N				T _b /T _N
1800 r/min = 4 poles			460 V 60 Hz			High-output design									
5.5	M3AA 112MC 4	3GAA112330---K	1762	91.7	91.3	89.3	0.75	10	10.1	29.9	4.3	5.0	0.0234	50	66
9.2	M3AA 132MD 4	3GAA132340---K	1770	91.7	91.8	90.9	0.78	15.9	9.5	49.6	3.3	4.6	0.0392	65	77
11	M3AA 132SME 4	3GAA132250---K	1771	92.4	92.6	91.7	0.78	18.9	9.3	59.4	3.4	4.5	0.0468	88	77
15	M3AA 132SMF 4	3GAA132260---K	1769	93.0	93.2	92.2	0.78	25.8	9.9	80.9	3.7	5.2	0.0545	88	77
18.5	M3AA 160MLC 4	3GAA162430---K	1778	93.6	93.6	92.7	0.76	32.4	8.2	99.3	3.8	4.0	0.12	135	71
28	M3AA 180MLC 4	3GAA182430---K	1784	94.1	93.7	92.4	0.79	50.8	9.2	160.59	3.12	3.77	0.191	176	65
37	M3AA 200MLB 4	3GAA202420---K	1785	94.5	94.3	93.4	0.81	60.5	9.1	198.2	3.5	3.6	0.362	244	68
49	M3AA 225SMC 4	3GAA222230---K	1787	95	94.8	93.8	0.85	78.9	10.7	261.84	3.79	4.13	0.532	318	75
75	M3AA 250SMB 4	3GAA252220---K	1785	95.4	95.4	94.7	0.81	121	8.5	402.8	3.75	3.7	0.796	389	77

Frame sizes 90-132 are available as premodified motors with following variant codes:

- 338 - Rated for gas or dust, Ex ec IIC T3 Gc / Ex tc IIIB T125C Dc (non-conductive dust), IP5X
- 339 - Rated for gas or dust, Ex ec IIC T3 Gc / Ex tc IIIC T125C Dc (conductive dust), IP6X.

When ordering frame sizes 160-250, select appropriate variant code:

- 335- Ex t, Dust group III B T125C Dc, IP5X
- 336 -Ex t, Dust group III C T125 Db, IP6X
- 456 - Ex ec IIC T3 Gc acc. IEC/EN 60079-7

Technical data, 460 V 60 Hz

IE3 Increased safety Ex ec & Ex t aluminum motors

IP 55 - IC 411 - Insulation class F, temperature rise class B

IE3 efficiency class according to IEC 60034-30-1: 2014

Output kW	Motor type	Product code	Speed r/min	Efficiency IEC 60034-30-1: 2014			Power factor Cos ϕ	Current		Torque		Moment of inertia J = 1/4 GD ² kgm ²	Weight kg	Sound pressure Level L _{PA} dB	
				Full load 100%	3/4 load 75%	1/2 load 50%		I _N A	I _s /I _N	T _N Nm	T _r /T _N				T _b /T _N
1200 r/min = 6 poles			460 V 60 Hz			CENELEC-design									
0.75	M3AA 90LD 6	3GAA093540-...K	1148	82.5	81.8	78.3	0.73	1.56	5.1	6.2	2.2	2.8	0.0055	19	61
1.1	M3AA 100LE 6	3GAA103550-...K	1168	87.5	87.5	85.8	0.66	2.3	6.3	9.0	2.4	3.5	0.0138	35	52
1.5	M3AA 100LF 6	3GAA103560-...K	1174	88.5	87.1	83.7	0.62	3.3	7.7	12.2	3.5	4.7	0.0138	35	52
2.2	M3AA 112MC 6	3GAA113330-...K	1172	89.5	89.6	88.4	0.66	4.6	7.3	17.9	2.5	4.0	0.0187	43	71
3	M3AA 132MC 6	3GAA133330-...K	1181	89.5	89.4	88.1	0.67	6.3	7.0	24.2	2.2	3.5	0.0402	66	64
4	M3AA 132MD 6	3GAA133340-...K	1176	89.5	89.9	88.9	0.69	8.0	6.2	32.4	2.0	3.0	0.0402	67	64
5.5	M3AA 132ME 6	3GAA133350-...K	1177	91.0	91.3	90.4	0.72	10.4	6.6	44.6	2.1	3.3	0.039	63	64
7.5	M3AA 160MLA 6	3GAA163410-...K	1182	91.4	91.5	90.3	0.76	13.5	8.6	60.5	1.8	3.7	0.114	125	63
11	M3AA 160MLB 6	3GAA163420-...K	1183	91.7	91.8	90.5	0.73	20.6	9.4	88.7	2.3	4.4	0.131	139	63
15	M3AA 180MLA 6	3GAA183410-...K	1189	92.3	92.0	90.5	0.75	27.1	6.0	120.0	1.8	3.1	0.225	175	63
18.5	M3AA 200MLA 6	3GAA203410-...K	1191	93.3	93.2	92.1	0.77	32.3	8.6	148.0	2.9	3.6	0.448	218	67
22	M3AA 200MLB 6	3GAA203420-...K	1191	93.8	93.8	92.8	0.78	37.7	8.8	176.0	2.9	3.6	0.531	245	67
30	M3AA 225SMA 6	3GAA223210-...K	1191	94.2	94.3	93.6	0.80	49.9	8.9	240.0	3.2	3.5	0.813	310	67
37	M3AA 250SMA 6	3GAA253210-...K	1192	94.5	94.7	94.1	0.82	59.9	8.6	296.0	3.0	3.2	1.49	367	67

Output kW	Motor type	Product code	Speed r/min	Efficiency IEC 60034-30-1: 2014			Power factor Cos ϕ	Current		Torque		Moment of inertia J = 1/4 GD ² kgm ²	Weight kg	Sound pressure Level L _{PA} dB	
				Full load 100%	3/4 load 75%	1/2 load 50%		I _N A	I _s /I _N	T _N Nm	T _r /T _N				T _b /T _N
1200 r/min = 6 poles			460 V 60 Hz			High-output design									
18.5	M3AA 180MLB 6	3GAA183420-...K	1183	93.0	93.0	92.1	0.69	36.1	8.2	149	2.6	3.7	0.197	168	69
37	M3AA 225SMB 6	3GAA223220-...K	1188	94.1	94.1	93.2	0.80	61.8	8.0	297.4	3.0	3.3	0.813	307	72
45	M3AA 250SMB 6	3GAA253220-...K	1193	94.5	94.4	93.4	0.77	77.5	8.3	361.7	3.4	3.9	1.33	389	72

Frame sizes 90-132 are available as premodified motors with following variant codes:

- 338 - Rated for gas or dust, Ex ec IIC T3 Gc / Ex tc IIIB T125C Dc (non-conductive dust), IP5X
- 339 - Rated for gas or dust, Ex ec IIC T3 Gc / Ex tc IIIC T125C Dc (conductive dust), IP6X.

When ordering frame sizes 160-250, select appropriate variant code:

- 335- Ex t, Dust group III B T125C Dc, IP5X
- 336 -Ex t, Dust group III C T125 Db, IP6X
- 456 - Ex ec IIC T3 Gc acc. IEC/EN 60079-7

Variant codes

Increased safety Ex ec & Ex t aluminum motors

Variant codes specify additional options and features to the standard motor. The desired features are listed as three-digit variant codes in the motor order. Note also that there are variants that cannot be used together.

Most of the variant codes apply to IE2 and IE3 motors. However, confirm the availability of variants for IE3 motors with your ABB sales office before making an order.

Code/Variants	Frame size								
	90	100	112	132	160	180	200	225	250
Administration									
531 Sea freight packing.	•	•	•	•	•	•	•	•	•
Balancing									
052 Vibration acc. to Grade A (IEC 60034-14).	○	○	○	○	○	○	○	○	○
426 Half key balancing.	○	○	○	○	○	○	○	○	○
Bearings and Lubrication									
037 Roller bearing at D-end.	-	-	-	-	•	•	•	•	•
039 Cold-resistant grease.	○	○	○	○	○	○	○	○	○
040 Heat-resistant grease.	○	○	○	○	○	○	○	○	○
041 Bearings regreasable via grease nipples.	•	•	•	•	•	•	•	•	•
042 Locked D-end	○	○	○	○	○	○	○	○	○
043 SPM compatible nipples for vibration measurement.	-	-	-	-	•	•	•	•	•
057 2RS bearings at both ends.	○	○	○	○	•	•	•	•	•
188 63-series bearing in D-end.	•	○	○	•	○	○	○	○	○
194 2Z bearings greased for life at both ends	-	-	-	-	○	○	○	○	○
195 Bearings greased for life	○	○	○	○	○	○	○	○	○
593 Bearings grease suitable for food and beverage industry.	-	-	-	-	•	•	•	•	•
798 Stainless steel grease nipples.	-	-	-	-	•	•	•	•	•
Branch standard designs									
178 Stainless steel / acid proof bolts.	-	-	-	-	•	•	•	•	•
217 Cast iron D-end shield (on aluminum motor).	•	•	•	•	○	○	○	○	○
232 Cast iron N-end shield (on aluminium motor)	-	-	-	-	○	○	○	○	○
425 Corrosion protected stator and rotor core.	-	-	-	-	•	•	•	•	•
Cooling system									
046 Two-directional fan.	○	○	○	○	○	○	○	○	○
053 Metal fan cover.	○	○	○	○	○	○	○	○	○
068 Light alloy metal fan.	○	○	○	○	•	•	•	•	•
792 Metal fasteners for fan cover.	○	○	○	○	○	○	○	○	○
Documentation									
141 Binding 2D main dimension drawing.	-	-	-	-	•	•	•	•	•
Drain holes									
065 Plugged existing drain holes.	-	-	-	-	•	•	•	•	•
Earthing Bolt									
067 External earthing bolt.	○	○	○	○	○	○	○	○	○
Hazardous Environments									
335 Ex t, Dust group III B T125C Dc, IP5X (non-conductive dust) acc. IEC/EN60079-31.	-	-	-	-	•	•	•	•	•
336 Ex t, Dust group III C T125 Db, IP6X (conductive dust) acc. IEC/EN60079-31.	-	-	-	-	•	•	•	•	•
338 Rated for gas or dust, Ex ec IIC T3 Gc / Ex tc IIIB T125C Dc (non-conductive dust), IP5X.	○	○	○	○	-	-	-	-	-
339 Rated for gas or dust, Ex ec IIC T3 Gc / Ex tc IIIC T125C Dc (conductive dust), IP6X.	○	○	○	○	-	-	-	-	-
456 Ex ec IIC T3 Gc acc. IEC/EN 60079-7 with certificates.	○	○	○	○	•	•	•	•	•
Heating elements									
450 Heating element, 100-120 V.	•	•	•	•	•	•	•	•	•
451 Heating element, 200 - 240 V.	•	•	•	•	•	•	•	•	•
Mounting arrangements									
007 IM 3001 flange mounted, IEC flange, from IM 1001 (B5 from B3).	-	-	-	-	•	•	•	•	•
008 IM 2101 foot/flange mounted, IEC flange, from IM 1001 (B34 from B3).	•	•	•	•	-	-	-	-	-

○ = Included as standard | • = Available as option | - = Not applicable

Code/Variants	Frame size									
	90	100	112	132	160	180	200	225	250	
009	IM 2001 foot/flange mounted, IEC flange, from IM 1001 (B35 from B3).	●	●	●	●	●	●	●	●	●
047	IM 3601 flange mounted, IEC flange, from IM 3001 (B14 from B5).	●	●	●	●	-	-	-	-	-
048	IM 3001 flange mounted, IEC flange, from IM 3601 (B5 from B14).	●	●	●	●	-	-	-	-	-
066	Modified for specified mounting position differing from IM B3 (1001), IM B5 (3001), B14 (3601), IM B35 (2001), IM B34 (2101).	●	●	●	●	●	●	●	●	●
200	Flange ring holder.	●	●	●	●	-	-	-	-	-
224	Flange ring FT 115.	●	-	-	-	-	-	-	-	-
226	Flange ring FF 130.	●	●	●	-	-	-	-	-	-
227	Flange ring FT 130.	●	●	●	-	-	-	-	-	-
233	Flange ring FF 165.	●	●	●	-	-	-	-	-	-
234	Flange ring FT 165.	●	●	●	-	-	-	-	-	-
243	Flange ring FF 215.	-	-	●	●	-	-	-	-	-
Painting										
114	Special paint color, standard grade.	●	●	●	●	●	●	●	●	●
Protection										
005	Protective roof.	●	●	●	●	●	●	●	●	●
072	Radial seal at D-end. Not possible for 2-pole, 280 and 315 frames.	-	-	-	-	●	●	●	●	●
074	Degree of protection IP55.	○	○	○	○	○	○	○	○	○
158	Degree of protection IP65.	○	○	○	○	●	●	●	●	●
250	Degree of protection IP66.	-	-	-	-	●	●	●	●	●
403	Degree of protection IP56.	-	-	-	-	●	●	●	●	●
784	Gamma-seal at D-end.	○	○	○	○	○	○	○	○	○
Rating & instruction plates										
002	Restamping voltage, frequency and output, continuous duty.	●	●	●	●	●	●	●	●	●
003	Individual serial number.	○	○	○	○	○	○	○	○	○
004	Additional text on std rating plate (max 12 digits on free text line).	●	●	●	●	●	●	●	●	●
095	Restamping output (maintained voltage, frequency), intermittent duty.	-	-	-	-	●	●	●	●	●
098	Stainless rating plate.	●	●	●	●	●	●	●	●	●
126	Tag plate.	●	●	●	●	●	●	●	●	●
135	Mounting of additional identification plate, stainless.	●	●	●	●	●	●	●	●	●
138	Mounting of additional identification plate, aluminium.	●	●	●	●	●	●	●	●	●
159	Additional plate with text "Made in".	-	-	-	-	●	●	●	●	●
160	Additional rating plate affixed.	-	-	-	-	●	●	●	●	●
161	Additional rating plate delivered loose.	-	-	-	-	●	●	●	●	●
162	Rating plate fixed to stator	○	○	○	○	○	○	○	○	○
163	Frequency converter rating plate. Rating data according to quotation.	●	●	●	●	●	●	●	●	●
181	Rating plate with ABB standard loadability values for VSD operation. Other auxiliaries for VSD operation to be selected as necessary.	●	●	●	●	●	●	●	●	●
Shaft & rotor										
164	Shaft extension with closed keyway	○	○	○	○	○	○	○	○	○
Standards and Regulations										
331	Motor not for sale for use in EU.	●	●	●	●	●	●	●	●	●
538	CE mark	○	○	○	○	○	○	○	○	○
Stator winding temperature sensors										
436	PTC - thermistors (3 in series), 150 °C, in stator winding.	●	○	○	○	○	○	○	○	○
445	Pt100 2-wire in stator winding, 1 per phase.	-	-	-	-	●	●	●	●	●
Terminal box										
015	Motor supplied in D connection.	-	-	-	-	●	●	●	●	●
017	Motor supplied in Y connection.	-	-	-	-	●	●	●	●	●
230	Standard metal cable gland.	●	●	●	●	●	●	●	●	●
465	Terminal box on top.	○	○	○	○	○	○	○	○	○
731	Two standard metal cable glands.	-	-	-	-	●	●	●	●	●
738	Prepared for metric cable glands.	○	○	○	○	○	○	○	○	○
Testing										
145	Type test report from a catalogue motor, 400V 50Hz.	●	●	●	●	●	●	●	●	●
148	Routine test report.	●	●	●	●	●	●	●	●	●
Variable speed drives										
701	Insulated bearing at N-end.	-	-	-	-	●	●	●	●	●

○ = Included as standard | ● = Available as option | - = Not applicable

Code/Variants	Frame size									
	90	100	112	132	160	180	200	225	250	
704 EMC cable entry.	•	•	•	•	•	•	•	•	•	•
Y/D starting										
023 6 terminals (for Y/D start, single speed), in terminal box.	○	○	○	○	○	○	○	○	○	○

○ = Included as standard | • = Available as option | - = Not applicable

* Valid only for registered motors (Motor type M3AA with generation K)

Dimension drawings

Increased safety Ex ec & Ex t aluminum motors

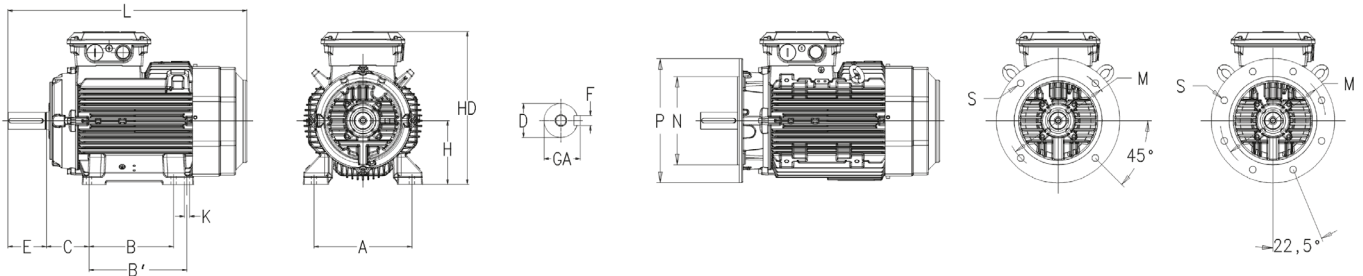

Foot-mounted motor IM1001, B3 and flange-mounted motor IM3001, B5

Motor size	Poles	D	GA	F	E	L max	A	B	B1	HD	HD	K	M	N	P	S
90	2-6	24	27	8	50	336.5	140	125		56	217	10	165	130	200	12
100	2-6	28	31	8	60	437	160	140		63	237	12	215	180	250	15
112	2-6 ¹⁾	28	31	8	60	436	190	140		70	260	12	215	180	250	15
112	4 ²⁾	28	31	8	60	482	190	140		70	260	12	215	180	250	15
132	2-6 ¹⁾	38	41	10	80	492	216	140	178	89	298	12	265	230	300	14.5
132	2-4 ^{3), 4)}	38	41	10	80	555	216	140	212	89	321	12	265	230	300	14.5
132	4 ⁵⁾	38	41	10	80	595	216	140	212	89	321	12	265	230	300	14.5
160	MLA 2-6, MLB2	42	45	12	110	584	254	210	254	108	370	15	300	250	350	19
160	MLB 4-6, MLC 2-6, MLD 2-4	42	45	12	110	681	254	210	254	108	370	15	300	250	350	19
180	2-6	48	51.5	14	110	726	279	241	279	121	405	15	300	250	350	19
200	2-6	55	59	16	110	821	318	267	305	133	506	18	400	350	400	19
225	2	55	59	16	110	850	356	286	311	149	553	18	400	350	450	19
225	4-6	60	64	18	140	880	356	286	311	149	553	18	400	350	450	19
250	2	60	64	18	140	884	406	311	349	168	601	22	500	450	550	19
250	4-6	65	69	18	140	884	406	311	349	168	601	22	500	450	550	19

¹⁾ all types except ²⁾ 4p 5,5kW (HO) ³⁾ 2p 11/15kW (HO)

⁴⁾ 4p 11kW (HO) ⁵⁾ 4p 15kW (HO)

IMB14 (IM3601)

Motor size	M	N	P	S
90	115	95	140	8
100	130	110	160	8
112	130	110	160	8
132	165	130	200	10
132SM_	165	130	200	10

Tolerances		Tolerances	
A, B	±0,8	F	ISO h9
	ISO j6 ≤ Ø 28 mm	H	-0,5
D	ISO k6 < Ø 38 mm	N	ISO js6
	ISO m6 ≥ Ø 55 mm	C	±0,8

The table gives the main dimension in mm. For detailed drawings please see our web pages new.abb.com/motors-generators.

Motors in brief

Ex ec & Ex t aluminum motors, sizes 90 - 132

Motor size	M3AA	90	100	112	132
Stator and end shields	Material	Die-cast aluminum alloy			
	Paint colour shade	Munsell blue 8B 4.5/3.25			
	Corrosion class	C3 medium			
Feet	Integrated aluminum feet				
Bearings	D-end	6205-2RS1/C3	6306-2RS1/C3	6306-2RS1/C3	6208-2RS1/C3
	N-end	6204-2RS1/C3	6205-2RS1/C3	6205-2RS1/C3	6206-2RS1/C3
Axially-locked bearings	Inner bearing cover	Locked at D-end			
Bearing seal	D-end	Gamma ring			
	N-end	Gamma ring			
Lubrication	Permanently lubricated shielded & sealed bearings				
Measuring nipples for condition monitoring of the bearings	Not included				
Rating plate	Material	Aluminum			
Terminal box	Material	Die-cast aluminum alloy, integrated to stator frame			
	Corrosion class	C3 Medium			
	Cover screws material	Zinc-electroplated steel			
Connections	Openings	2x(M20+M25)			2x(M20+M25)
	Blank with Ex plugs				2x(M40+M32+M12)
	Terminals	6 terminals for connection with cable lugs			
	Cable glands	Optional			
Fan	Material	Light alloy metal fan			
	Material	Steel			
Fan cover	Paint colour shade	Munsell blue 8B 4.5/3.25			
	Corrosion class	C3 Medium			
	Material	Copper			
Stator winding	Insulation	Insulation class F			
	Winding protection	3 PTC thermistors, 150 °C			
Rotor winding	Material	Die-cast aluminum			
Balancing	Half key balancing as standard				
Key ways	Closed key way				
Drain holes	Drain holes with closable plastic plugs, for IP55 opened, for IP65 closed				
External earthing bolt	As standard				
Enclosure	IP55 or IP65				
Cooling method	IC411				

Motors in brief

Ex ec & Ex t aluminum motors, sizes 160 - 250

Motor size	M3AA	160	180	200	225	250
Stator	Material	Die-cast aluminum alloy				
	Paint colour shade	Munsell blue 8B 4.5/3.25				
	Corrosion class	C3 medium				
End shields	Material	Cast iron				
Feet		Separate aluminum feet		Separate cast iron feet		
Bearings	D-end	6309-2Z/C3	6310-2Z/C3	6312-2Z/C3	6313-2Z/C3	6315-2Z/C3
	N-end	6209-2Z/C3	6209-2Z/C3	6210-2Z/C3	6212-2Z/C3	6213-2Z/C3
Axially-locked bearings	Inner bearing cover	Locked at D-end				
Bearing seal	D-end	Gamma ring				
	N-end	Gamma ring				
Lubrication		Permanently lubricated shielded bearings				
Measuring nipples for condition monitoring of the bearings		Not included				
Rating plate	Material	Aluminum				
	Material	Die-cast aluminum alloy				
Terminal box	Corrosion class	C3 medium				
	Cover screws material	Zinc-electroplated steel				
	Openings	2x(2xM40+M16)				
Connections	Blank with Ex plugs	Knock-out		2x (2xM40+2xM16) or 2x (2xM63+2xM16)		
	Terminals	6 terminals for connection with cable lugs				
	Cable glands	Optional				
Fan	Material	Light alloy metal fan				
	Material	Steel				
Fan cover	Paint colour shade	Munsell blue 8B 4.5/3.25				
	Corrosion class	C3 medium				
	Material	Copper				
Stator winding	Insulation	Insulation class F				
	Winding protection	3 PTC thermistors, 150 °C				
Rotor winding	Material	Die-cast aluminum				
Balancing		Half key balancing				
Key ways		Closed key way				
Drain holes		Drain holes with closable plastic plugs, for IP55 opened, for IP65 closed				
External earthing bolt		As standard				
Enclosure		IP 55 or IP65				
Cooling method		IC411				

Low voltage Brake aluminum motors

Sizes 71-180, 0,12 to 22 kW

76	Brake aluminum motors
78	Ordering information
79	Rating plates
80	Technical data
80	IE3 Aluminum brake motors
81	IE2 Aluminum brake motors
82	Variant codes
85	Mechanical design
86	Brake design
91	Dimension drawings
92	Motors in brief

Brake aluminum motors

Brake motors keep the rotor position fixed when power supply is shut-off and effectively enable to slow down and stop the driven equipment in a short time.

ABB brake aluminum motors are standard motors modified for braking duties, i.e. three phase induction motors with standard dimensions and output rating. The electro-magnetic disc brake is powered by DC current through a rectifier located in terminal box. When the brake coil is de-energized, the brake is actuated by spring pressure.

ABB brake motors are highly acclaimed in the market due to its high performance and ensuring a reliable service over the lifetime. The comprehensive range is offering full compliance to the global standards, high efficiency for energy and cost savings, as well as competitive delivery times.

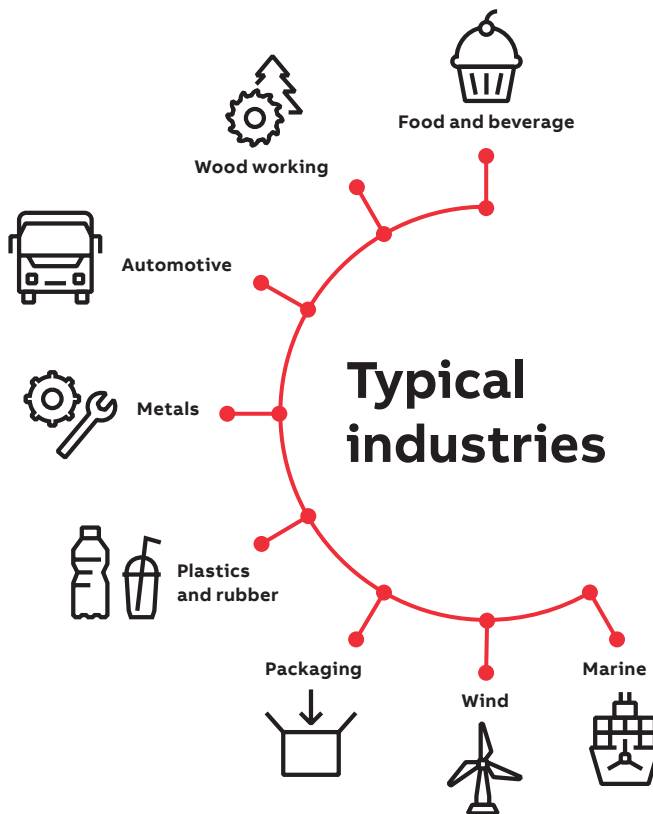

Key features

Motor features

- Easy installation with wide terminal box and brake rectifier included in the terminal box
- Standard connection of the rectifier, directly to motor terminals
- Mounting in any position
- Temperature rise B and insulation class F
- IP 55
- With standard motors' dimensions and output ratings
- Hand release fitted as an option
- Technical and application support
- Service and support

Brake features

The pre-assembled electromagnetic brake is in conformity with relevant EU harmonized legislations. It is suitable for parking and emergency stop braking industrial applications.

- Compact design with torque from 4 to 235 Nm
- Brake disc highest security, lowest wear and maintenance
- Easy installation
- IP54 as standard
- Duty cycle: 100% energized is allowed
- Non-stick friction material
- UL certified



Ordering information

Explanation of the product code

Motor type	Motor size	Product code	Code for mounting arrangement, Voltage and frequency code, Generation code followed by variant codes
M3AA	112MB	3GAA 111	320 - ASK, 843, 003 etc.
		1 2 3 4 5 6 7	8 9 10 11 12 13 14...

Positions 1 to 4
3GAA: Totally enclosed motor with aluminum stator frame

Positions 5 and 6

IEC size	IEC size
07: 71	11: 112
08: 80	13: 132
09: 90	16: 160
10: 100	18: 180

Position 7

Pole pairs

1:	2 poles
2:	4 poles
3:	6 poles

Positions 8 to 10
Running number

Position 11
- (dash)

Position 12 (marked with black dot in data tables)

Mounting arrangement

A:	Foot-mounted motor
C:	Flange-mounted motor. Small flange with tapped holes.
E:	Flange-mounted motor. Large flange with clearance holes, available for frame sizes 112-132.
H:	Foot- and flange-mounted motor. Large flange with clearance holes.
J:	Foot- and flange-mounted motor. Small flange with tapped holes.

Position 13 (marked with black dot in data tables)

Voltage and frequency code

Single-speed motors

D:	400 VΔ, 415 VΔ, 690 VY 50 Hz
S:	230 VΔ, 400 VY, 415 VY 50 Hz

Position 14
Version
A, B, C...: Generation code followed by variant codes

Efficiency values are given according to IEC 60034-2-1; 2014

Rating plates

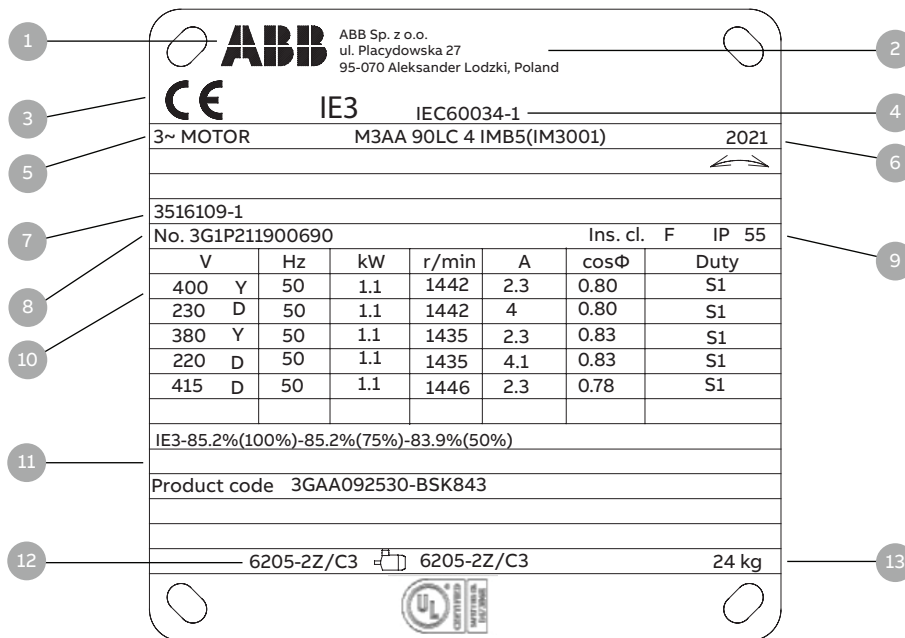

- 1 ABB logo
- 2 Manufacturing place
- 3 CE mark on Ecodesign approved motors UKCA mark on UK approved motors
- 4 Manufacturing standard
- 5 Product description
- 6 Manufacturing year
- 7 Factory order reference number
- 8 Serial number
- 9 Insulation class, IP protection class
- 10 Voltage, Frequency, output, speed, current, power factory, duty
- 11 Product code
- 12 Bearing type
- 13 Weight

Technical data

IE3 Aluminum brake motors

IP 55 - IC 411 - Insulation class F, temperature rise class B - Brake IP54
IE3 efficiency class according to IEC 60034-30-1; 2014

Out-put kW	Motor type designation	Product code ¹⁾	Speed r/min	Efficiency IEC 60034-30-1; 2014			Power factor Cosφ	Current		Torque				Torque, brake		Moment of inertia J = 1/4 GD ² kgm ²	Weight kg	Sound pressure Level L _{PA} dB
				Full load 100%	3/4 load 75%	1/2 load 50%		I _N A	I _s /I _N	T _N Nm	T _v /T _N	T _b /T _N	T _L /T _{Nm}	K ²				
3000 r/min = 2 poles			400 V 50 Hz															
0.75	M3AA 80MB 2	3GAA081320-...K	2894	80.7	80.4	77.2	0.74	1.74	7.9	2.4	3.7	4.2	8	3.3	0.0008	12.5	57	
1.1	M3AA 80MC 2	3GAA081330-...K	2883	82.7	82.4	80.6	0.81	2.3	7.9	3.6	3.7	4.2	8	2.2	0.001	13.5	56	
1.5	M3AA 90LB 2	3GAA091520-...K	2906	84.2	84.8	84.7	0.89	2.8	7.9	4.9	2.3	3.3	16	3.3	0.0027	23	60	
2.2	M3AA 90LC 2	3GAA091530-...K	2900	85.9	87.4	87.5	0.89	4.0	8.3	7.2	2.9	3.5	16	2.2	0.0032	26	60	
3	M3AA 100LC 2	3GAA101530-...K	2896	87.1	88.2	88.0	0.90	5.4	8.4	9.8	3.2	3.9	32	3.3	0.0057	36	62	
4	M3AA 112MB 2	3GAA111320-...K	2888	88.1	89.4	89.6	0.91	7.1	8.4	13.2	3.2	4.0	40	3.0	0.0104	48	68	
5.5	M3AA 132SB 2	3GAA131120-...K	2901	89.2	89.9	90.1	0.91	9.7	7.9	18.1	2.3	3.4	80	4.4	0.0154	73	68	
7.5	M3AA 132SC 2	3GAA131130-...K	2909	90.1	91.2	91.4	0.90	13.1	8.3	24.6	3.0	3.9	80	3.3	0.0173	78	70	
11	M3AA 160MLA 2	3GAA161410-...K	2943	91.2	92.0	91.6	0.91	19.1	7.2	35.7	2.6	3.6	165	4.6	0.057	125	69	
15	M3AA 160MLB 2	3GAA161420-...K	2947	91.9	92.2	91.8	0.88	26.7	8.2	48.6	3.2	4.2	165	3.4	0.063	142	69	
18.5	M3AA 160MLC 2	3GAA161430-...K	2949	92.4	93.0	92.6	0.90	32.1	9.0	59.9	3.3	3.9	165	2.8	0.076	156	73	
22	M3AA 180MLA 2	3GAA181410-...K	2956	92.7	93.1	92.7	0.90	37.7	7.8	71	3.0	3.8	235	3.3	0.11	194	73	
1500 r/min = 4 poles			400 V 50 Hz															
0.75	M3AA 80ME 4	3GAA082350-...K	1440	82.5	82.4	80.2	0.76	1.7	7.9	4.9	3.3	3.7	8	1.6	0.0027	16.5	54	
1.1	M3AA 90LC 4	3GAA092530-...K	1442	84.1	83.5	81.7	0.80	2.3	7.9	7.2	3.3	3.9	16	2.2	0.0055	25	56	
1.5	M3AA 90LD 4	3GAA092540-...K	1439	85.3	84.7	82.8	0.78	3.2	8.2	9.9	3.5	4.0	16	1.6	0.0055	25	51	
2.2	M3AA 100LE 4	3GAA102550-...K	1454	86.7	87.1	86.0	0.83	4.3	8.9	14.5	3.1	4.1	32	2.2	0.0144	44	54	
3	M3AA 100LF 4	3GAA102560-...K	1452	87.7	88.1	87.1	0.83	5.9	9.0	19.7	3.5	4.2	32	1.6	0.0144	44	54	
4	M3AA 112MB 4	3GAA112320-...K	1451	88.6	89.4	89.0	0.77	8.6	7.6	26.3	3.1	4.1	40	1.5	0.018	58	59	
5.5	M3AA 132MB 4	3GAA132320-...K	1464	89.6	90.2	89.5	0.78	11.4	7.0	35.9	2.8	3.9	80	2.2	0.0295	83	70	
7.5	M3AA 132MC 4	3GAA132330-...K	1464	90.4	90.8	90.7	0.81	14.7	7.7	48.9	2.5	3.6	80	1.6	0.0414	83	64	
11	M3AA 160MLA 4	3GAA162410-...K	1477	91.4	91.8	91.1	0.82	21.1	7.6	71.3	2.6	3.3	165	2.3	0.11	145	61	
15	M3AA 160MLB 4	3GAA162420-...K	1474	92.1	92.2	91.3	0.81	29	7.8	97.2	3.0	3.6	165	1.7	0.135	159	61	
18.5	M3AA 180MLA 4	3GAA182410-...K	1481	92.6	93.2	92.9	0.83	34.9	7.2	119	2.8	3.0	235	2.0	0.219	195	60	
22	M3AA 180MLB 4	3GAA182420-...K	1480	93.0	93.8	93.8	0.82	41.5	8.2	141	2.8	3.1	235	1.7	0.217	194	62	
1000 r/min = 6 poles			400 V 50 Hz															
0.75	M3AA 90LD 6	3GAA093540-...K	937	78.9	79.6	77.3	0.76	1.8	4.6	7.6	2.1	2.3	16	2.1	0.0055	25	55	
1.1	M3AA 100LE 6	3GAA103550-...K	963	81.0	82.2	81.0	0.69	2.6	5.6	10.9	2.3	3.1	32	2.9	0.0138	43	49	
1.5	M3AA 100LF 6	3GAA103560-...K	969	82.5	81.4	77.5	0.65	3.7	7	14.7	3.3	4.1	32	2.2	0.0138	43	49	
2.2	M3AA 112MC 6	3GAA113330-...K	967	84.3	85.2	84.1	0.69	5.2	6.5	21.7	2.4	3.5	40	1.8	0.0187	53	68	
3	M3AA 132MC 6	3GAA133330-...K	978	85.6	86.0	84.5	0.69	7.0	6.2	29.2	2.0	3.0	80	2.7	0.0402	81	61	
4	M3AA 132MD 6	3GAA133340-...K	973	86.8	87.7	87.5	0.72	9.1	5.6	39.2	1.9	2.7	80	2.0	0.0402	82	61	
5.5	M3AA 132ME 6	3GAA133350-...K	973	88.0	88.8	88.2	0.74	12	5.8	53.9	2	2.9	80	1.5	0.039	78	61	
7.5	M3AA 160MLA 6	3GAA163410-...K	980	89.1	89.9	89.3	0.78	15.2	7.9	73	1.7	3.3	165	2.6	0.114	144	59	
11	M3AA 160MLB 6	3GAA163420-...K	979	90.3	90.9	90.2	0.74	23.5	8.5	107	2.2	3.9	265	1.5	0.131	158	59	
15	M3AA 180MLA 6	3GAA183410-...K	987	91.2	91.5	90.5	0.77	30.4	5.5	146	1.7	2.7	265	1.6	0.225	193	59	

¹⁾ Note: Mandatory variant code 843 for DC brake.

²⁾ K-braking torque ratio

Technical data

IE2 Aluminum brake motors

IP 55 - IC 411 - Insulation class F, temperature rise class B - Brake IP54
IE2 efficiency class according to IEC 60034-30-1; 2014

Out-put kW	Motor type designation	Product code ¹⁾	Speed r/min	Efficiency IEC 60034-30-1; 2014			Power factor Cosφ	Current		Torque, motor				Torque, brake		Moment of inertia J = 1/4 GD ² kgm ²	Weight kg	Sound pressure Level L _{PA} dB
				Full load 100%	3/4 load 75%	1/2 load 50%		I _N A	I _s /I _N	T _N Nm	T _v / T _N	T _v / T _N	T _b / T _{Nm}	K ²				
3000 r/min = 2 poles				400 V 50 Hz														
0.37	M3AA 71A 2	3GAA071311-**-E	2785	69.5	70.8	67.8	0.79	0.91	4.6	1.26	2.5	2.8	4	3.2	0.0004	7.5	58	
0.55	M3AA 71B 2	3GAA071312-**-E	2790	74.1	75.4	73.4	0.79	1.29	5.1	1.88	3.1	3.1	4	2.1	0.0005	7.5	58	
1500 r/min = 4 poles				400 V 50 Hz														
0.25	M3AA 71A 4	3GAA072311-**-E	1430	68.5	66.8	59.5	0.67	0.76	4.7	1.67	2.2	3.0	4	2.4	0.0006	7.5	45	
0.37	M3AA 71B 4	3GAA072312-**-E	1411	72.7	73.3	69.9	0.74	0.96	5.2	2.5	2.6	2.9	4	1.6	0.001	8.5	45	
0.55	M3AA 80A 4	3GAA082311-**-E	1406	77.1	78.6	78.6	0.78	1.29	5.4	3.73	2.8	2.6	8	2.1	0.0022	11.5	50	
1000 r/min = 6 poles				400 V 50 Hz														
0.18	M3AA 71A 6	3GAA073311-**-E	870	56.6	58.7	54.8	0.71	0.61	2.8	1.97	1.9	2.0	4	2.0	0.0009	8	42	
0.25	M3AA 71B 6	3GAA073312-**-E	890	61.6	61.8	56.7	0.68	0.84	3.1	2.68	2.3	2.4	4	1.5	0.0012	9	42	
0.55	M3AA 80C 6	3GAA083313-**-E	905	73.1	75.9	75.1	0.76	1.42	4.4	5.8	2.7	2.55	8	1.4	0.0034	18	50	

¹⁾ Note: Mandatory variant code 843 for DC brake.

²⁾ K-braking torque ratio

Variant codes

Variant codes specify additional options and features to the standard motor. The desired features are listed as three-digit variant codes in the motor order. Note also that there are variants that cannot be used together.

Most of the variant codes apply to IE2 and IE3 motors. For details please contact your ABB sales office before making an order.

Code/Variant	Frame size							
	71	80	90	100	112	132	160	180
Administration								
531 Sea freight packing.	•	•	•	•	•	•	•	•
Balancing								
052 Vibration acc. to Grade A (IEC 60034-14).	○	○	○	○	○	○	○	○
426 Half key balancing	○	○	○	○	○	○	○	○
Bearings and Lubrication								
037 Roller bearing at D-end.	-	-	-	-	-	-	•	•
039 Cold-resistant grease.	○	○	○	○	○	○	○	○
040 Heat-resistant grease.	○	○	○	○	○	○	○	○
041 Bearings regreasable via grease nipples.	-	-	•	•	•	•	•	•
042 Locked D-end.	○	○	○	○	○	○	○	○
043 SPM compatible nipples for vibration measurement	-	-	-	-	-	-	•	•
057 2RS bearings at both ends.	•	•	•	•	•	•	•	•
188 63-series bearing in D-end.	-	-	•	○	○	•	○	○
194 2Z bearings greased for life at both ends.	○	○	○	○	○	○	○	○
195 Bearings greased for life.	○	○	○	○	○	○	○	○
Branch standard designs								
178 Stainless steel / acid proof bolts.	•	•	•	•	•	•	•	•
217 Cast iron D-end shield (on aluminum motor).	-	-	•	•	•	○	○	○
232 Cast iron N-end shield (on aluminium motor).	○	○	○	○	○	○	○	○
425 Corrosion protected stator and rotor core.	•	•	•	•	•	•	•	•
Brakes								
086 Reconnection of brake for separate ac supply.	•	•	•	•	•	•	-	-
088 Brake with mechanical release.	•	•	•	•	•	•	-	-
288 Brake motor with voltage code S for the motor and separate supply of the brake for voltage corresponding to code D.	•	•	•	•	•	•	-	-
289 Brake motor with voltage code D for the motor and separate supply of the brake for voltage corresponding to code S.	•	•	•	•	•	•	-	-
298 Brake motor for 460V AC with voltage code S and D.	-	-	•	•	•	•	-	-
843 DC brake. (Sizes 71-132 available as premodified motors with 843)	○	○	○	○	○	○	•	•
Cooling system								
053 Metal fan cover.	○	○	○	○	○	○	○	○
068 Light alloy metal fan.	•	•	•	•	•	•	•	•
183 Separate motor cooling (fan axial, N-end).	•	•	•	•	•	•	•	•
205 Non metallic fan.	○	○	○	○	○	○	○	○
046 Two-directional fan.	○	○	○	○	○	○	○	○
792 Metal fasteners for fan cover.	○	○	○	○	○	○	○	○
Documentation								
141 Binding 2D main dimension drawing.	•	•	•	•	•	•	•	•
Drain holes								
065 Plugged existing drain holes.	-	-	-	-	-	-	•	•
Earthing Bolt								
067 External earthing bolt.	•	•	•	•	•	•	•	•
Heating elements								
450 Heating element, 100-120 V	•	•	•	•	•	•	•	•
451 Heating element, 200 - 240 V	•	•	•	•	•	•	•	•

○ = Included as standard | • = Available as option | - = Not applicable

Code/Variant		Frame size							
		71	80	90	100	112	132	160	180
Marine									
496	Fulfilling Bureau Veritas (BV) requirements, without certificate(non-essential duty only)	•	•	•	•	•	•	•	•
Mounting arrangements									
008	IM 2101 foot/flange mounted, IEC flange, from IM 1001 (B34 from B3).	•	•	•	•	•	•	•	-
009	IM 2001 foot/flange mounted, IEC flange, from IM 1001 (B35 from B3).	•	•	•	•	•	•	•	•
047	IM 3601 flange mounted, IEC flange, from IM 3001 (B14 from B5).	•	•	•	•	•	•	•	-
048	IM 3001 flange mounted, IEC flange, from IM 3601 (B5 from B14).	•	•	•	•	•	•	-	-
066	Modified for specified mounting position differing from IM B3 (1001), IM B5 (3001), B14 (3601), IM B35 (2001), IM B34 (2101)	•	•	•	•	•	•	•	•
200	Flange ring holder.	•	•	•	•	•	•	-	-
223	Flange ring FF 115.	•	•	•	-	-	-	-	-
224	Flange ring FT 115.	•	•	•	-	-	-	-	-
226	Flange ring FF 130.	•	•	•	•	•	-	-	-
227	Flange ring FT 130.	•	•	•	•	•	-	-	-
233	Flange ring FF 165.	-	•	•	•	•	-	-	-
234	Flange ring FT 165.	•	•	•	•	•	-	-	-
243	Flange ring FF 215.	-	-	-	-	•	•	-	-
253	Flange ring FF 265.	-	-	-	-	-	•	-	-
255	Flange FF 265.	-	-	-	-	-	•	-	-
260	Flange FT 115.	-	-	•	-	-	-	-	-
Painting									
114	Special paint color, standard grade	•	•	•	•	•	•	•	•
Protection									
005	Protective roof	•	•	•	•	•	•	•	•
072	Radial seal at D-end. Not possible for 2-pole , 280 and 315 frames	•	•	•	•	•	•	•	•
074	Degree of protection IP55.	○	○	○	○	○	○	○	○
784	Gamma-seal at D-end.	•	•	•	•	•	•	•	•
Rating & instruction plates									
002	Restamping voltage, frequency and output, continuous duty.	•	•	•	•	•	•	•	•
003	Individual serial number	○	○	○	○	○	○	○	○
004	Additional text on std rating plate (max 12 digits on free text line).	•	•	•	•	•	•	•	•
095	Restamping output (maintained voltage, frequency), intermittent duty.	•	•	•	•	•	•	•	•
098	Stainless rating plate.	•	•	•	•	•	•	•	•
126	Tag plate	•	•	•	•	•	•	•	•
135	Mounting of additional identification plate, stainless.	•	•	•	•	•	•	•	•
138	Mounting of additional identification plate, aluminium.	•	•	•	•	•	•	•	•
159	Additional plate with text Made in	•	•	•	•	•	•	•	•
160	Additional rating plate affixed.	-	-	•	•	•	•	•	•
161	Additional rating plate delivered loose.	•	•	•	•	•	•	•	•
162	Rating plate fixed to stator.	○	○	○	○	○	○	○	○
163	Frequency converter rating plate. Rating data according to quotation.	•	•	•	•	•	•	•	•
198	Aluminum rating plate.	○	○	○	○	○	○	○	○
Shaft & rotor									
164	Shaft extension with closed keyway	○	○	○	○	○	○	○	○
Code/Variant		Frame size							
		71	80	90	100	112	132	160	180
Standards and Regulations									
208	Fulfilling Underwriters Laboratories (UL), listed requirements	-	•	•	•	•	•	•	•
331	IE1 motor not for sale for use in EU	•	•	•	•	•	•	•	•
538	CE mark	○	○	○	○	○	○	○	○
586	UKCA mark	○	○	○	○	○	○	○	○
Stator winding temperature sensors									
122	Bimetal detectors, break type (NCC), (3 in series), 150 °C, in stator winding	-	•	•	•	•	•	•	•
436	PTC - thermistors (3 in series), 150 °C, in stator winding	•	•	•	○	○	○	○	○
445	Pt100 2-wire in stator winding, 1 per phase	-	-	-	-	-	•	•	•

○ = Included as standard | • = Available as option | - = Not applicable

Terminal box									
230	Standard metal cable gland.	●	●	●	●	●	●	●	●
375	Standard plastic cable gland	●	●	●	●	●	●	-	-
465	Terminal box on top	○	○	○	○	○	○	○	○
731	Two standard metal cable glands.	-	-	-	-	-	-	●	●
738	Prepared for metric cable glands.	○	○	○	○	○	○	○	○
Testing									
145	Type test report from a catalogue motor, 400V 50Hz.	●	●	●	●	●	●	●	●
148	Routine test report.	●	●	●	●	●	●	●	●
Y/D starting									
023	6 terminals (for Y/D start, single speed), in terminal box.	○	○	○	○	○	○	○	○

○ = Included as standard | ● = Available as option | - = Not applicable

Mechanical design

Degrees of protection

The degree of protection, as per 60034-5, is IP55 for the terminal box, electrical components of the brake and other motor parts.

Mechanical components of the brake IP54.

Mounting arrangements of brake motors

The design of the brake motor enables it to operate in any mounting position. Nevertheless, the position of the drain holes should be taken into account.

Vertically mounted motors with the shaft end downwards, intended for outdoor operation, should be provided with a protective roof to avoid water ingress and the possibility of ice forming on the brake.

Operation

ABB's brake motor is a standard motor modified for braking duties, i.e. a three phase induction motor with standard dimensions and output rating.

The electro-magnetic disc brake is powered, by DC current through a rectifier located in terminal box.

When the brake coil is de-energised, the brake is actuated by spring pressure.

The axial movement of the brake disc performs a dual braking action against the moving electromagnet and the motor shield, without pressure or impact being transmitted to the bearings.

Lubrication and bearings

The bearings incorporate two Z-type non-friction sealing plates. The amount of grease is sufficient for the life of the bearing.

Standard design: deep groove ball bearings as listed below:

Motor size	D-end	N-end
71	6203-2Z/C3	6203-2Z/C3
80	6204-2Z/C3	6204-2Z/C3
90	6205-2Z/C3	6205-2Z/C3
100	6306-2Z/C3	6206-2Z/C3
112	6306-2Z/C3	6206-2Z/C3
132	6308-2Z/C3	6208-2Z/C3
160	6309-2Z/C3	6209-2Z/C3
180	6310-2Z/C3	6209-2Z/C3

Brake design

—
01 Brake disc for frame sizes 71-112 (ERX-35)

—
02 Brake disc for frame sizes 132-180 (ERX-60-200)

General

Electromagnetic disc brakes work by the action of a set of springs and are released when applying voltage to the brake coil.

This means that the motor will brake automatically in case of any voltage failure, as a significant safety feature. The brake is always functional, irrespective of the mounting position of the brake motor.

Detailed view

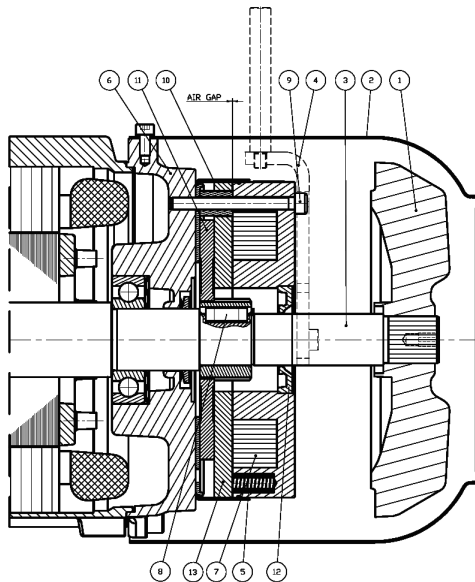

- 1 Fan
- 2 Fan cover
- 3 Shaft
- 4 Hand release lever (option 088)
- 5 Pressure spring
- 6 Motor N-end shield
- 7 Brake magnet
- 8 Brake key
- 9 Mounting screw
- 10 Dust cover
- 11 Brake disc
- 12 Lip seal
- 13 Armature plate

Brake disc

The friction discs have been designed to provide consistent and reliable braking performance in a wide range of conditions.

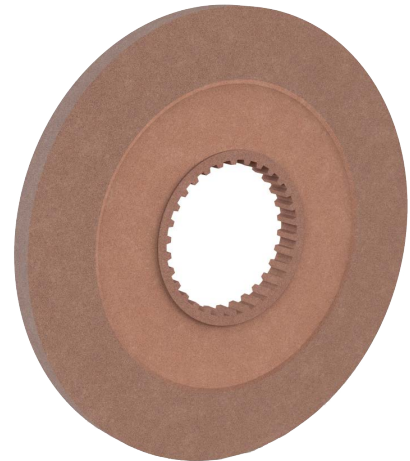

—
01



—
02

From the first principle, the friction material has been designed to deliver static and dynamic braking functions with high torque stability. Furthermore, it offers consistent performance across varying rotational speeds and a wide range of environmental conditions. The material is non-sticking with a high friction coefficient.

The friction material was put through a rigorous battery of in-house testing to ensure that it's best-in-class performance.

Replacing the brake disc

The brake disc must be replaced when reaching the maximum airgap stated in Table 1.

Rectifier

The rectifier is a device for DC brake applications. It is highly resistant to temperature as well as to voltage peaks. Its compact design enables it to be placed in the motor terminal box.

Connection for DC brake¹⁾

The brake is fed via a rectifier. The voltage stated on the brake rating plate is that of the brake coil on the DC side of the rectifier.

The coil can operate reliably between of 90 % and 110 % of the rated voltage. For voltages outside these limits, please consult ABB.

Standard brake release time

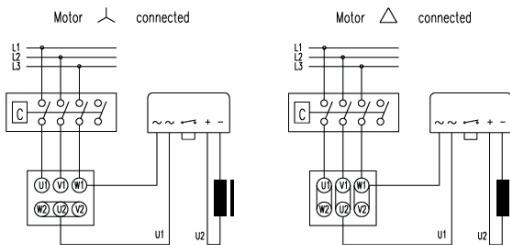

Reconnection (t21=)

To obtain fast braking time, please see table 2 (t21=), use the following diagram.

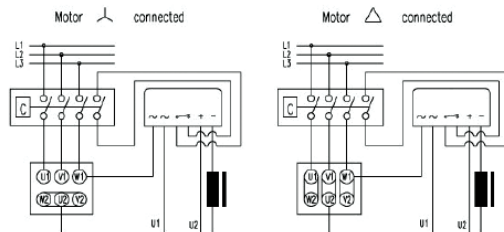

Reconnection (t21~)

When it is necessary to reduce the fast braking time, the connections should be modified according to the following diagram. The breaking of the circuit on the AC side is controlled by using an auxiliary contact of the contactor.

¹⁾ Separate brake connection is compulsory when the motor is driven by a variable speed drive.

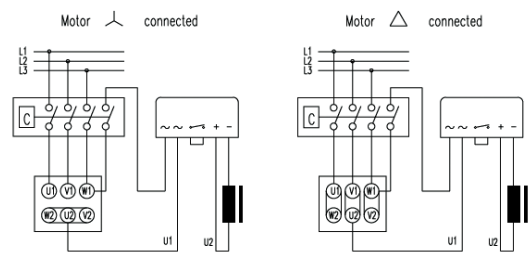

Reconnection of brake for separate ac supply

To obtain separate AC supply, please use following diagram.

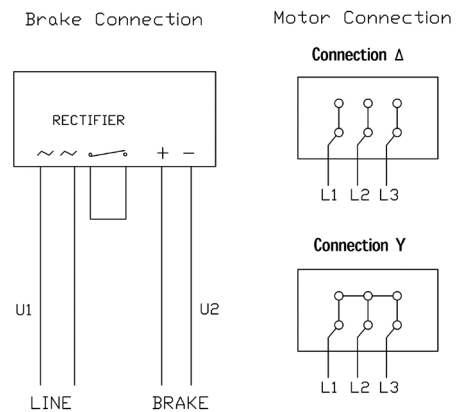

Hand release

The device is a lever used to override the action of the brake springs for as long as it is applied. Hand release is available as an option, see variant code 088.

When installing the release level, please proceed as follows:

ERX5 to ERX60

- 1 Tighten lever handle on lever until to have it blocked.

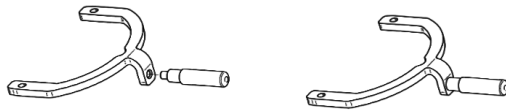

- 2 Insert lever springs into the brake.
- 3 Put lever screws through the lever and tighten the screws into the brake until to have them blocked.

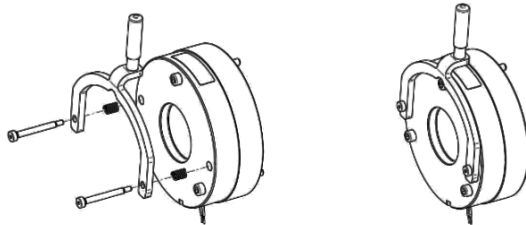

ERX200

- 1 Insert lever pins into the brake with hammer (tight fit).

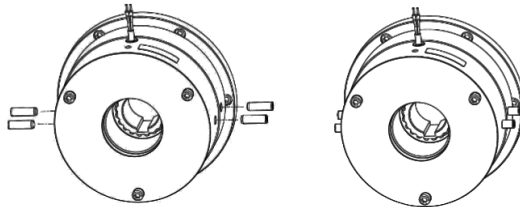

- 2 Insert lever systems on lever pins.

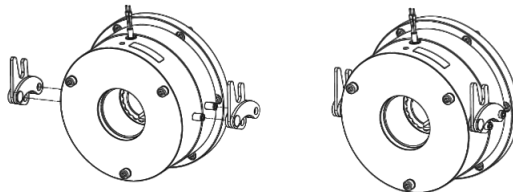

- 3 Insert lever handle in lever systems.

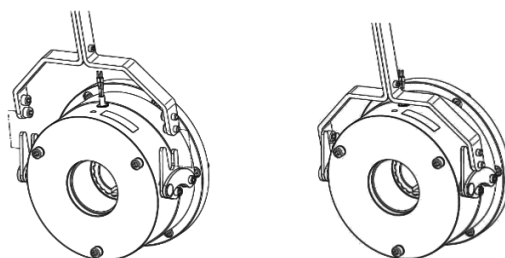

Torque adjustment

In brake motors from frame size 71 up to 180, the braking torque is set to the nominal torque as standard. Reduced braking torque up to 50%, is available by using variant code 087.

Brake operating times

The operating times stated in brake data table 2 are valid for the nominal air gap and warmed-up brake coil.

- t_1 = Brake release time
- t_{21} = Braking time
- U_2 = Rated voltage
- T_B = Nominal braking torque

Brake release time = the time from when voltage is applied to the brake coil up to the ceasing of braking action.

Braking time = the time from when the current is switched off up to the starting of braking action.

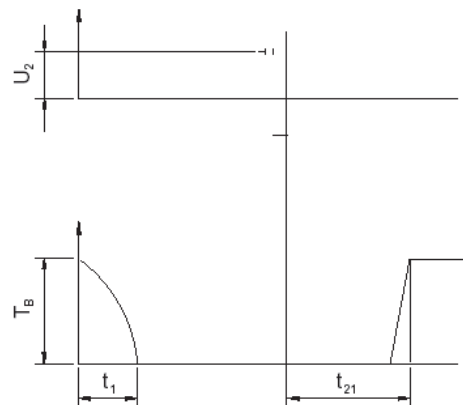

Brake voltages

The standard brake coil connection voltages for 50 Hz will be those stated in the following table, unless stated otherwise in the order:

Rectifier input voltage (V_{Ac})	Rectifier type ¹⁾	D.C. coil brake voltage (V)
220	H.W	103
230	H.W	103
240	H.W	103
380	H.W	180
400	H.W	180
415	H.W	180
500	H.W	225 ²⁾
24 V_{DC}	None	24 ³⁾

¹⁾ H.W. = Half-wave rectifier

²⁾ Special coil on request

³⁾ Available using variant code 285

Brake design

Data tables

Table 1.

Brake motor size		71	80	90	100	112	132	160	180
Brake type		ERX 5	ERX 10	ERX 20	ERX 35	ERX 35	ERX 60	ERX 200	ERX 200
Rated torque ¹⁾	T_{Bnom} (Nm)	4	8	16	32	40	80	165	235
Nominal air gap	X (mm)	0.25	0.25	0.25	0.25	0.25	0.25	0.35	0.35
Maximum air gap	Xn (mm)	0.6	0.6	0.6	0.6	0.6	0.6	0.7	0.7
Thickness of new brake disc	E_m (mm)	6.5	8.1	7	7	7	7.9	8	8
Tightening torque: bolt	C_s (Nm)	2.7	5.2	9	9	9	22	22	22
Max. Input coil:									
- DC brake motor	(W)	19-23	20-25	36-39	42-47	42-47	36-59	69-85	69-85
Moment of inertia	J (kgm ²)	4.5×10^{-3}	1.2×10^{-2}	3.2×10^{-2}	1×10^{-1}	1×10^{-1}	1.7×10^{-1}	3.6×10^{-1}	5.8×10^{-1}
Weight	(kg)	1.3	1.6	3.8	5	5	6.6	14	14

¹⁾ Rated torque is guaranteed for the brand new brakes (no running or burnishing required)

In general, all the variables mentioned above can affect the braking torque values, so if an accurate value is needed, ABB recommends it is measured in the real application.

Graph 1.

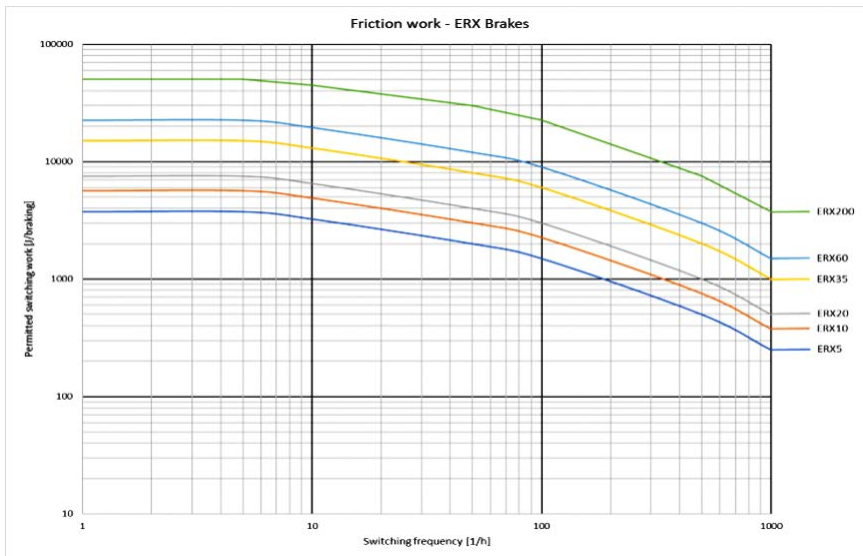

Table 2.

Brake motor sizes		71	80	90	100/112	132	160	160/180
DC Brake size		ERX 5	ERX 10	ERX 20	ERX 35	ERX 200	ERX 200	ERX 200
Brake release time t_1	ms	70	90	110	130	180	350	350
Standard braking time t_{21} (AC)	ms	250	250	500	700	750	650	650
Fast braking time t_{21f} (DC)	ms	30	30	50	80	160	100	100

Brake design

Calculations

Maximum number of connection per hour

The connection frequency that may be achieved with the motors is limited by the temperature rise that they undergo both in the coil and in the rotor. The brakes are designed so that they may withstand the kinds of duty for which these motors are intended.

The maximum number of connections per hour depends on:

- the power P_2 required after reaching the rated speed, i.e. the relative load P with regard to the rated power P_n

$$P = \frac{P_2}{P_n} \times 100 \%$$

- the total inertia J in kgm^2 of the mass to be accelerated (inertia of the rotor J_m as per catalogue, plus the additional inertia J_b of the driven machine) in relation to the motor shaft, that is, J_b multiplied by the square of the coefficient of the load speed divided by the motor speed.

$$J = J_m + J_b \times \left[\frac{n_b}{n_m} \right]^2$$

- the relative duration factor for service S4.

$$S4 = \frac{\text{connection time}}{\text{connection time} + \text{downtime}} \times 100 \text{ in } \%$$

For calculations of the maximum number of connections/hour, please consult ABB.

Required data:

- Type of brake motor
- Load inertia reduced at motor shaft
- Required power P_2
- Type of service

Permitted friction work per operation

Friction work per operation must not exceed the WR_{\max} values stated in brake data table 1.

$$WR = \frac{1}{2} \times J \times \left[\frac{\pi \times n_m}{30} \right]^2 \text{ in joules}$$

Friction work per hour

The friction work can be calculated if the number of operations per hour is known.

This value must be equal to or less than the PR_{\max} stated in brake data table 1.

$$PR = WR \times c/h$$

Options

When the motor is supplied via a frequency converter, the brake should be supplied separately at rated voltage (constant). The separate brake supply can be connected directly, no separate terminal box is needed.

Protective roof

To protect motors from accumulation of water, ice or snow when installed outdoors in the

vertical position and with the shaft downwards, the assembly should be fitted with a protective roof.

Variant code 005 should in this case be stated in the order.

Dimension drawings

Brake motors, sizes 71-180

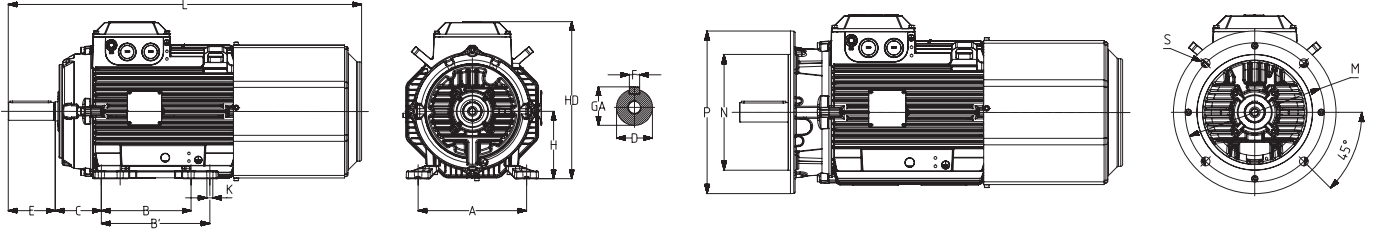

	IM B3 (IM 1001), IM 1002										IM B5 (IM3001), IM 3002				IMB14 (IM3601)				
Motor size	D	GA	F	E	L max	A	B	B'	C	HD	K	M	N	P	S	M	N	P	S
71	14	12.5	5	30	312	112	90		45	180	7	130	110	160	10	85	70	105	6
80	19	21.5	6	40	379	125	100		50	193.5	10	165	130	200	12	100	80	120	6
90	24	27	8	50	418	140	125		56	217	10	165	130	200	12	115	95	140	8
100	28	31	8	60	533.5	160	140		63	237	12	215	180	250	15	130	110	160	8
112	28	31	8	60	556.5	190	140		70	260	12	215	180	250	15	130	110	160	8
132	38	41	10	80	611.5	216	140	178	89	298	12	265	230	300	14.5	165	130	200	10
160 ¹⁾	42	45	12	110	705	254	210	254	105	370	15	300	250	350	19				
160	42	45	12	110	827	254	210	254	108	370	15	300	250	350	19				
180	48	51.5	14	110	847	279	279	279	121	405	15	300	250	350	19				

Tolerances		Tolerances	
A, B	±0,8	F	ISO h9
D	ISO j6 ≤ Ø 28 mm	H	-0,5
	ISO k6 < Ø 38 mm	N	ISO js6
	ISO m6 ≥ Ø 55 mm	C	±0,8

¹⁾ IE3 160 MLA 2-pole

Motors in brief

Brake motors

Motor size		71	80	90	100	112	132	160	180	
Stator and end shields	Material stator	Die-cast aluminum alloy								
	Material D-end	Die-cast aluminum alloy							Cast iron	
	Material N-end	Cast iron								
	Paint colour shade	Munsell blue 8B 4.5/3.25								
	Corrosion class	C3 according to IEO/EN 12944-5								
Feet	Material	Integrated aluminum feet							Separate aluminum feet	
Bearings	D-end	6203-2Z/C3	6204-2Z/C3	6205-2Z/C3	6306-2Z/C3	6306-2Z/C3	6208-2Z/C3	6309-2Z/C3	6310-2Z/C3	
	N-end	6203-2Z/C3	6204-2Z/C3	6205-2Z/C3	6206-2Z/C3	6206-2Z/C3	6208-2Z/C3	6209-2Z/C3	6209-2Z/C3	
Axially locked bearings	Inner bearing cover	Locked at D-end								
Bearing seal	D-end	V-ring							V-ring	
	V-ring	V-ring							V-ring	
Lubrication		Permanently lubricated bearings. Grease for bearing temperatures -40...+160 °C								
Measuring nipples for condition monitoring of the bearings		Not included								
Rating plates	Material	Aluminum								
	Material	Die-cast aluminum alloy, integrated to stator								
Terminal box	Cover screw materials	Zinc-electroplated steel								
Connections	Openings	2 x (M20 + M20)		2 x (M20 + M25)			2 x (M25 + M25) ¹⁾		2 x (M40 + M32 + M12) ²⁾ 2 x (M40+M16)+2x(M40)	
	Terminals	6 terminals for connecton with cable lugs (not included)								
	Cable glands	Optional								
Fan	Material	Glass-fiber enforces polypropylene								
Fan cover	Material	Steel								
	Paint color shade	Munsell blue 8B 4.5/3.25								
	Corrosion class	C3								
Stator winding	Material	Copper								
	Insulation	Insulation class F								
	Winding protection	Optional							3 PTC thermistors, 150 °C	
Rotor winding	Material	Die-cast aluminum								
Balancing		Half key balancing								
Key ways		Closed key way								
Drain holes		Drain holes with closable plastic plugs, open on delivery								
External earthing bolt		Optional								
Enclosure		Motor, terminal box and brake electrical components: IP 55								
		Brake mechanical components: IP54								
Cooling method		IC 411								

¹⁾ S, SB, M, MA

²⁾ SC, MC, SMA, SME

Total product offering

Motors, generators and mechanical power transmission products with a complete portfolio of services



IEC motors

- Low voltage motors
- High voltage induction and synchronous motors
- Marine motors
- Motors for explosive atmospheres
- Motors for food and beverage
- Motors for variable speed drives
- Permanent magnet motors
- Synchronous reluctance motors
- Traction motors

NEMA motors

- Low voltage motors
- High voltage induction and synchronous motors
- Marine motors
- Motors for explosive atmospheres
- Motors for variable speed drives
- Permanent magnet motors
- Servomotors
- Washdown motors

Generators

- Generators for wind turbines
- Generators for diesel and gas engine power plants
- Generators for steam and gas turbine power plants
- Generators for marine applications
- Generators for industrial applications
- Generators for traction applications
- Synchronous condensers for reactive power compensation

Mechanical power transmission components, bearings, gearings

- Mounted bearings
- Enclosed gearing
- Mechanical drive components
- Couplings
- Sheaves and bushings
- Conveyor components
- Geared motor units

Life cycle services

ABB's portfolio of drives

Optimal solution for you



Being able to rely on the continuous high performance and efficiency of your operations is something you want to take for granted. ABB variable-frequency drives are made with all this in mind, established upon more than 40 years of experience and backed by a broad range of life cycle services.

ABB drives help you to optimize your processes and systems with state-of-the-art motor control technology, resulting in increased energy efficiency, better product quality, and reduced operating costs with higher output, less downtime, and reduced need for maintenance. All ABB drives are designed for easy selection, ordering, installation and use, and they offer integrated safety features, giving you more time to focus on what matters for you and your business.

Our portfolio offers low-voltage AC and DC drives, medium-voltage AC drives, and motion control drives spanning the fractional-kilowatt to multi-megawatt power level. There is a drive available for essentially every industry and application and for all types of motors, in environments ranging from water utility facilities to clean electrical rooms, and to harsh coal mines and windy offshore platforms to food and beverage production. This wide product range allows you to select the best-fitting drive solution, providing maximum reliability and efficiency for every need.

—
For more information and contact details:

new.abb.com/motors-generators